



**Kent**

**Published 1931**

**Source map scale - 1:10,560**

The historical maps shown were reproduced from maps predominantly held at the scale adopted for England, Wales and Scotland in the 1840's. In 1854 the 1:2,500 scale was adopted for mapping urban areas; these maps were used to update the 1:10,560 maps. The published date given therefore is often some years later than the surveyed date. Before 1938, all OS maps were based on the Cassini Projection, with independent surveys of a single county or group of counties, giving rise to significant inaccuracies in outlying areas. In the late 1940's, a Provisional Edition was produced, which updated the 1:10,560 mapping from a number of sources. The maps appear unfinished - with all military camps and other strategic sites removed. These maps were initially overprinted with the National Grid. In 1970, the first 1:10,000 maps were produced using the Transverse Mercator Projection. The revision process continued until recently, with new editions appearing every 10 years or so for urban areas.

**Map Name(s) and Date(s)**

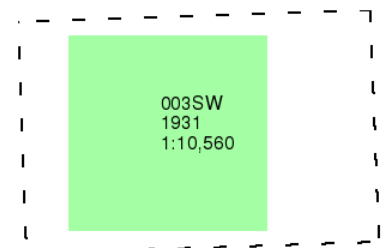

**Historical Map - Slice A**

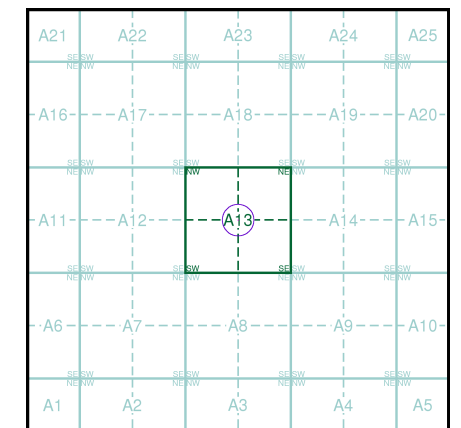

**Order Details**

Order Number: 159410216\_1\_1  
 Customer Ref: 42230  
 National Grid Reference: 551940, 177490  
 Slice: A  
 Site Area (Ha): 0.01  
 Search Buffer (m): 1000

**Site Details**

Larger Extent



Tel: 0844 844 9952  
 Fax: 0844 844 9951  
 Web: www.envirocheck.co.uk



Kent

Published 1938

Source map scale - 1:10,560

The historical maps shown were reproduced from maps predominantly held at the scale adopted for England, Wales and Scotland in the 1840's. In 1854 the 1:2,500 scale was adopted for mapping urban areas; these maps were used to update the 1:10,560 maps. The published date given therefore is often some years later than the surveyed date. Before 1938, all OS maps were based on the Cassini Projection, with independent surveys of a single county or group of counties, giving rise to significant inaccuracies in outlying areas. In the late 1940's, a Provisional Edition was produced, which updated the 1:10,560 mapping from a number of sources. The maps appear unfinished - with all military camps and other strategic sites removed. These maps were initially overprinted with the National Grid. In 1970, the first 1:10,000 maps were produced using the Transverse Mercator Projection. The revision process continued until recently, with new editions appearing every 10 years or so for urban areas.

Map Name(s) and Date(s)

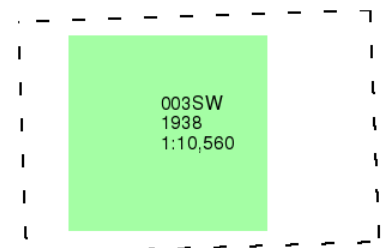

Historical Map - Slice A

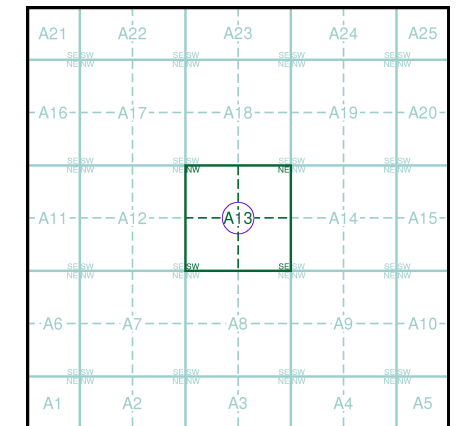

Order Details

Order Number: 159410216\_1\_1  
 Customer Ref: 42230  
 National Grid Reference: 551940, 177490  
 Slice: A  
 Site Area (Ha): 0.01  
 Search Buffer (m): 1000

Site Details

Larger Extent



Tel: 0844 844 9952  
 Fax: 0844 844 9951  
 Web: www.envirocheck.co.uk



**Essex**

**Published 1938**

**Source map scale - 1:10,560**

The historical maps shown were reproduced from maps predominantly held at the scale adopted for England, Wales and Scotland in the 1840's. In 1854 the 1:2,500 scale was adopted for mapping urban areas; these maps were used to update the 1:10,560 maps. The published date given therefore is often some years later than the surveyed date. Before 1938, all OS maps were based on the Cassini Projection, with independent surveys of a single county or group of counties, giving rise to significant inaccuracies in outlying areas. In the late 1940's, a Provisional Edition was produced, which updated the 1:10,560 mapping from a number of sources. The maps appear unfinished - with all military camps and other strategic sites removed. These maps were initially overprinted with the National Grid. In 1970, the first 1:10,000 maps were produced using the Transverse Mercator Projection. The revision process continued until recently, with new editions appearing every 10 years or so for urban areas.

**Map Name(s) and Date(s)**

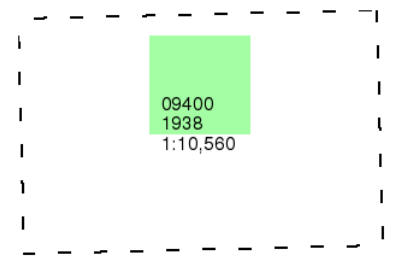

**Historical Map - Slice A**

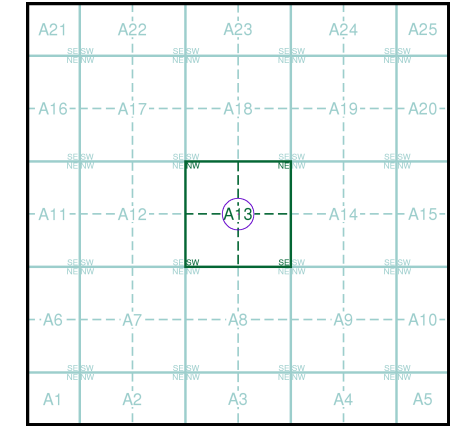

**Order Details**

Order Number: 159410216\_1\_1  
 Customer Ref: 42230  
 National Grid Reference: 551940, 177490  
 Slice: A  
 Site Area (Ha): 0.01  
 Search Buffer (m): 1000

**Site Details**

Larger Extent



Tel: 0844 844 9952  
 Fax: 0844 844 9951  
 Web: www.envirocheck.co.uk

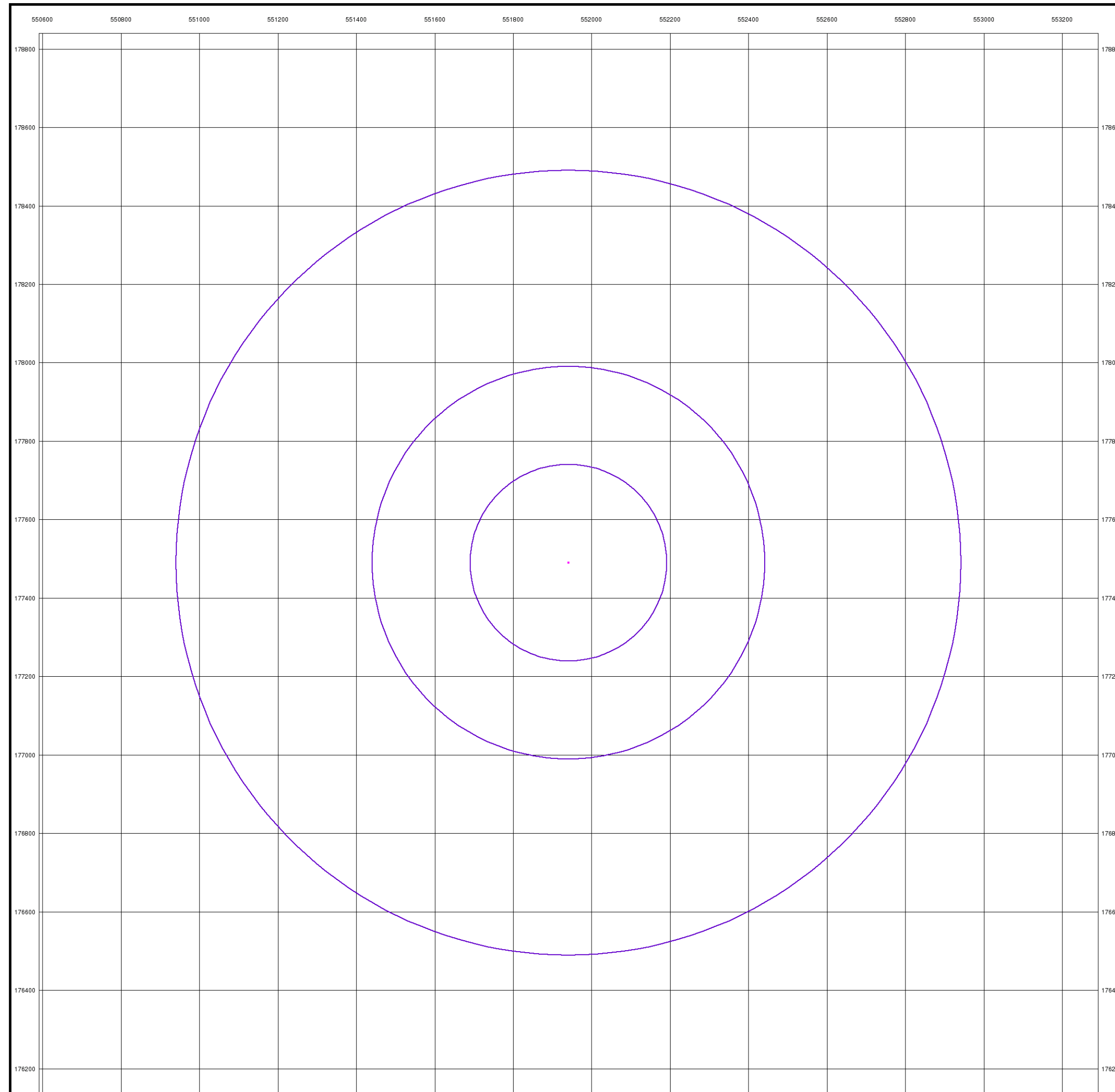

**London**

**Published 1938**

**Source map scale - 1:10,560**

The historical maps shown were reproduced from maps predominantly held at the scale adopted for England, Wales and Scotland in the 1840's. In 1854 the 1:2,500 scale was adopted for mapping urban areas; these maps were used to update the 1:10,560 maps. The published date given therefore is often some years later than the surveyed date. Before 1938, all OS maps were based on the Cassini Projection, with independent surveys of a single county or group of counties, giving rise to significant inaccuracies in outlying areas. In the late 1940's, a Provisional Edition was produced, which updated the 1:10,560 mapping from a number of sources. The maps appear unfinished - with all military camps and other strategic sites removed. These maps were initially overprinted with the National Grid. In 1970, the first 1:10,000 maps were produced using the Transverse Mercator Projection. The revision process continued until recently, with new editions appearing every 10 years or so for urban areas.

**Map Name(s) and Date(s)**

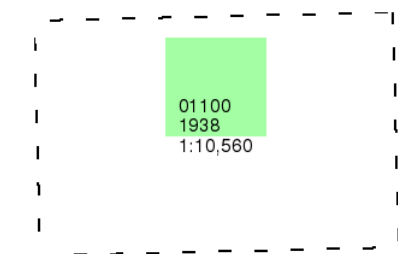

**Historical Map - Slice A**

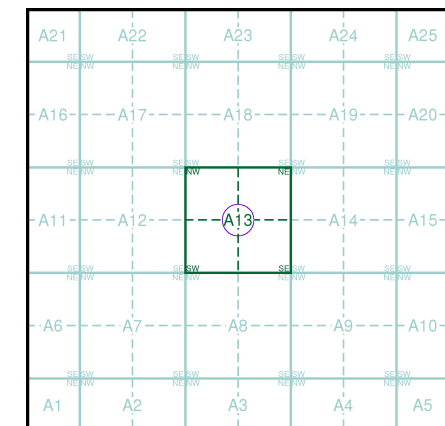

**Order Details**

Order Number: 159410216\_1\_1  
 Customer Ref: 42230  
 National Grid Reference: 551940, 177490  
 Slice: A  
 Site Area (Ha): 0.01  
 Search Buffer (m): 1000

**Site Details**

Larger Extent



Tel: 0844 844 9952  
 Fax: 0844 844 9951  
 Web: www.envirocheck.co.uk



## Historical Aerial Photography

Published 1948

Source map scale - 1:10,560

The Historical Aerial Photos were produced by the Ordnance Survey at a scale of 1:1,250 and 1:10,560 from Air Force photography. They were produced between 1944 and 1951 as an interim measure, pending preparation of conventional mapping, due to post war resource shortages. New security measures in the 1950's meant that every photograph was re-checked for potentially unsafe information with security sites replaced by fake fields or clouds. The original editions were withdrawn and only later made available after a period of fifty years although due to the accuracy of the editing, without viewing both revisions it is not easy to spot the edits. Where available Landmark have included both revisions.

© Landmark Information Group and/or Data Suppliers 2010.

### Map Name(s) and Date(s)

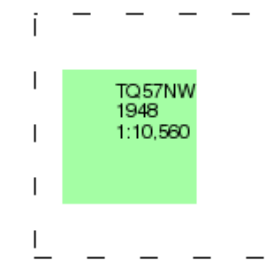

### Historical Aerial Photography - Slice A

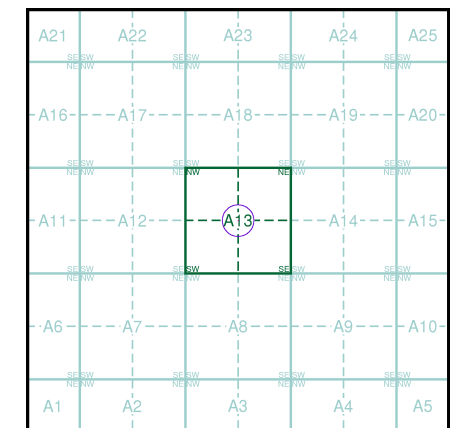

### Order Details

Order Number: 159410216\_1\_1  
 Customer Ref: 42230  
 National Grid Reference: 551940, 177490  
 Slice: A  
 Site Area (Ha): 0.01  
 Search Buffer (m): 1000

### Site Details

Larger Extent



Tel: 0844 844 9952  
 Fax: 0844 844 9951  
 Web: www.envirocheck.co.uk



Kent

Published 1950

Source map scale - 1:10,560

The historical maps shown were reproduced from maps predominantly held at the scale adopted for England, Wales and Scotland in the 1840's. In 1854 the 1:2,500 scale was adopted for mapping urban areas; these maps were used to update the 1:10,560 maps. The published date given therefore is often some years later than the surveyed date. Before 1938, all OS maps were based on the Cassini Projection, with independent surveys of a single county or group of counties, giving rise to significant inaccuracies in outlying areas. In the late 1940's, a Provisional Edition was produced, which updated the 1:10,560 mapping from a number of sources. The maps appear unfinished - with all military camps and other strategic sites removed. These maps were initially overprinted with the National Grid. In 1970, the first 1:10,000 maps were produced using the Transverse Mercator Projection. The revision process continued until recently, with new editions appearing every 10 years or so for urban areas.

Map Name(s) and Date(s)

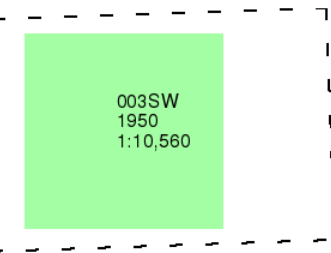

Historical Map - Slice A

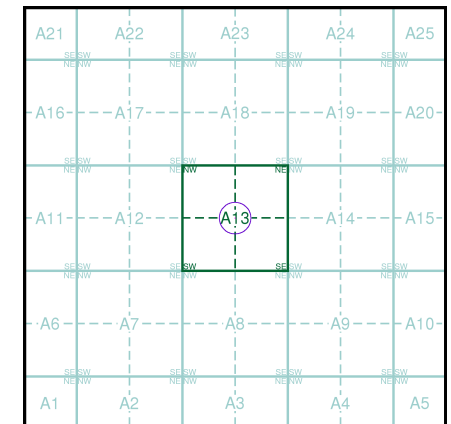

Order Details

Order Number: 159410216\_1\_1
Customer Ref: 42230
National Grid Reference: 551940, 177490
Slice: A
Site Area (Ha): 0.01
Search Buffer (m): 1000

Site Details

Larger Extent



Tel: 0844 844 9952
Fax: 0844 844 9951
Web: www.envirocheck.co.uk





**Ordnance Survey Plan**

**Published 1961**

**Source map scale - 1:10,000**

The historical maps shown were reproduced from maps predominantly held at the scale adopted for England, Wales and Scotland in the 1840's. In 1854 the 1:2,500 scale was adopted for mapping urban areas; these maps were used to update the 1:10,560 maps. The published date given therefore is often some years later than the surveyed date. Before 1938, all OS maps were based on the Cassini Projection, with independent surveys of a single county or group of counties, giving rise to significant inaccuracies in outlying areas. In the late 1940's, a Provisional Edition was produced, which updated the 1:10,560 mapping from a number of sources. The maps appear unfinished - with all military camps and other strategic sites removed. These maps were initially overprinted with the National Grid. In 1970, the first 1:10,000 maps were produced using the Transverse Mercator Projection. The revision process continued until recently, with new editions appearing every 10 years or so for urban areas.

**Map Name(s) and Date(s)**

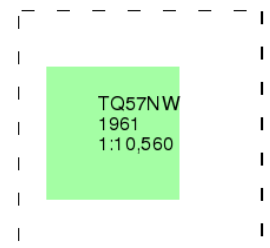

**Historical Map - Slice A**

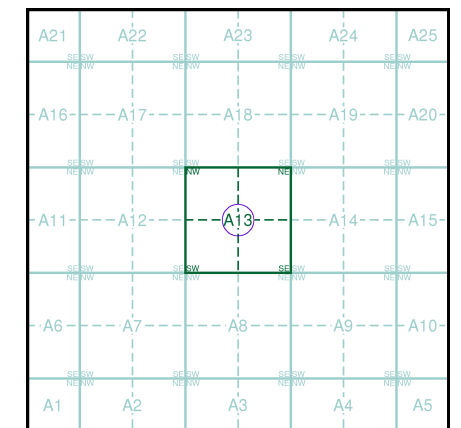

**Order Details**

Order Number: 159410216\_1\_1  
 Customer Ref: 42230  
 National Grid Reference: 551940, 177490  
 Slice: A  
 Site Area (Ha): 0.01  
 Search Buffer (m): 1000

**Site Details**

Larger Extent



Tel: 0844 844 9952  
 Fax: 0844 844 9951  
 Web: www.envirocheck.co.uk



## Ordnance Survey Plan

Published 1967

Source map scale - 1:10,000

The historical maps shown were reproduced from maps predominantly held at the scale adopted for England, Wales and Scotland in the 1840's. In 1854 the 1:2,500 scale was adopted for mapping urban areas; these maps were used to update the 1:10,560 maps. The published date given therefore is often some years later than the surveyed date. Before 1938, all OS maps were based on the Cassini Projection, with independent surveys of a single county or group of counties, giving rise to significant inaccuracies in outlying areas. In the late 1940's, a Provisional Edition was produced, which updated the 1:10,560 mapping from a number of sources. The maps appear unfinished - with all military camps and other strategic sites removed. These maps were initially overprinted with the National Grid. In 1970, the first 1:10,000 maps were produced using the Transverse Mercator Projection. The revision process continued until recently, with new editions appearing every 10 years or so for urban areas.

### Map Name(s) and Date(s)

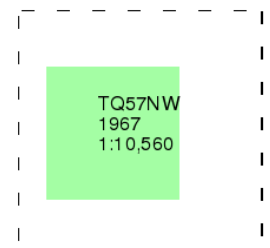

### Historical Map - Slice A

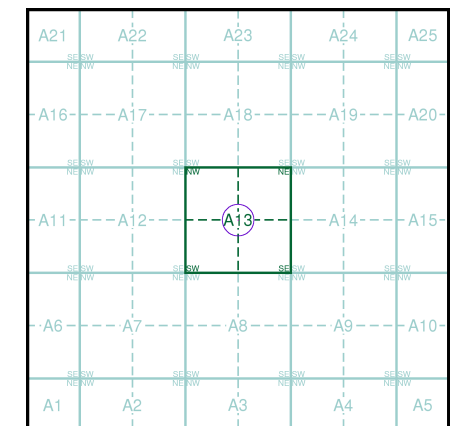

### Order Details

Order Number: 159410216\_1\_1  
 Customer Ref: 42230  
 National Grid Reference: 551940, 177490  
 Slice: A  
 Site Area (Ha): 0.01  
 Search Buffer (m): 1000

### Site Details

Larger Extent



Tel: 0844 844 9952  
 Fax: 0844 844 9951  
 Web: www.envirocheck.co.uk





### Ordnance Survey Plan

Published 1975

Source map scale - 1:10,000

The historical maps shown were reproduced from maps predominantly held at the scale adopted for England, Wales and Scotland in the 1840's. In 1854 the 1:2,500 scale was adopted for mapping urban areas; these maps were used to update the 1:10,560 maps. The published date given therefore is often some years later than the surveyed date. Before 1938, all OS maps were based on the Cassini Projection, with independent surveys of a single county or group of counties, giving rise to significant inaccuracies in outlying areas. In the late 1940's, a Provisional Edition was produced, which updated the 1:10,560 mapping from a number of sources. The maps appear unfinished - with all military camps and other strategic sites removed. These maps were initially overprinted with the National Grid. In 1970, the first 1:10,000 maps were produced using the Transverse Mercator Projection. The revision process continued until recently, with new editions appearing every 10 years or so for urban areas.

### Map Name(s) and Date(s)

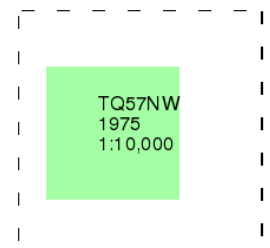

### Historical Map - Slice A

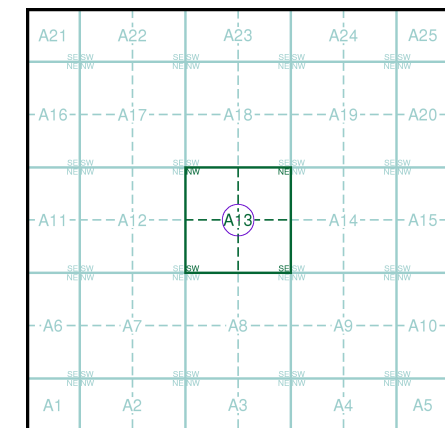

### Order Details

Order Number: 159410216\_1\_1  
 Customer Ref: 42230  
 National Grid Reference: 551940, 177490  
 Slice: A  
 Site Area (Ha): 0.01  
 Search Buffer (m): 1000

### Site Details

Larger Extent



Tel: 0844 844 9952  
 Fax: 0844 844 9951  
 Web: www.envirocheck.co.uk

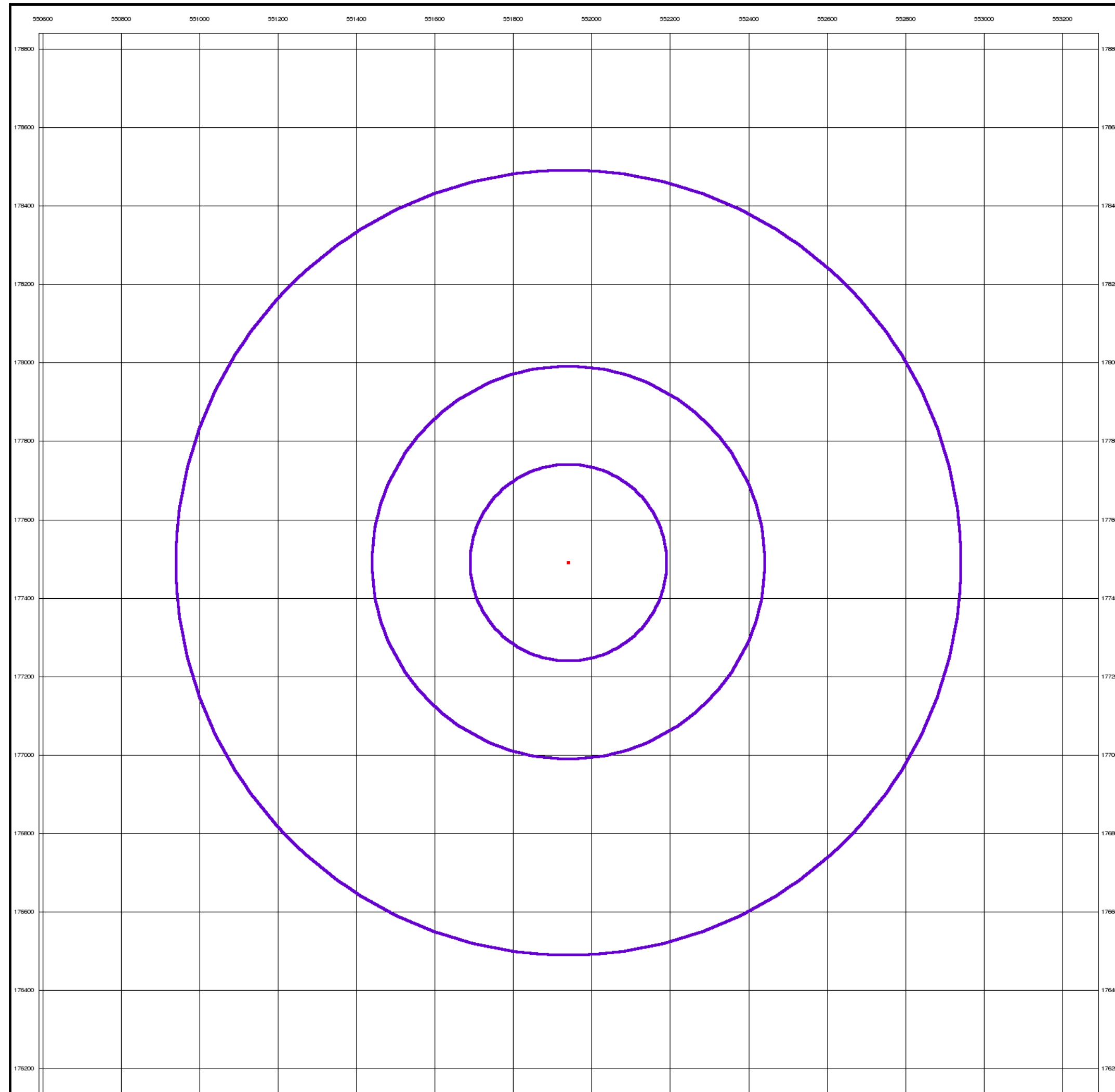

## Gravesend

Published 1977

Source map scale - 1:10,000

These maps were produced by the Russian military during the Cold War between 1950 and 1997, and cover 103 towns and cities throughout the U.K. The maps are produced at 1:25,000, 1:10,000 and 1:5,000 scale, and show detailed land use, with colour-coded areas for development, green areas, and non-developed areas. Buildings are coloured black and important building uses (such as hospitals, post offices, factories etc.) are numbered, with a numbered key describing their use.

They were produced by the Russians for the benefit of navigation, as well as strategic military sites and transport hubs, for use if they were to have invaded the U.K. The detailed information provided indicates that the areas were surveyed using land-based personnel, on the ground, in the cities that are mapped.

### Map Name(s) and Date(s)

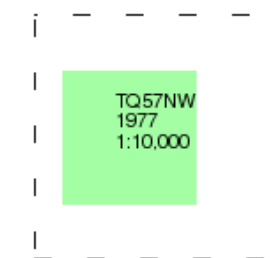

### Russian Map - Slice A

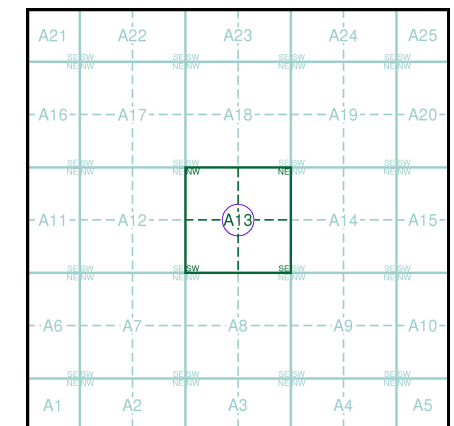

### Order Details

Order Number: 159410216\_1\_1  
 Customer Ref: 42230  
 National Grid Reference: 551940, 177490  
 Slice: A  
 Site Area (Ha): 0.01  
 Search Buffer (m): 1000

### Site Details

Larger Extent



Tel: 0844 844 9952  
 Fax: 0844 844 9951  
 Web: www.envirocheck.co.uk



London

Published 1985

Source map scale - 1:25,000

These maps were produced by the Russian military during the Cold War between 1950 and 1997, and cover 103 towns and cities throughout the U.K. The maps are produced at 1:25,000, 1:10,000 and 1:5,000 scale, and show detailed land use, with colour-coded areas for development, green areas, and non-developed areas. Buildings are coloured black and important building uses (such as hospitals, post offices, factories etc.) are numbered, with a numbered key describing their use.

They were produced by the Russians for the benefit of navigation, as well as strategic military sites and transport hubs, for use if they were to have invaded the U.K. The detailed information provided indicates that the areas were surveyed using land-based personnel, on the ground, in the cities that are mapped.

Map Name(s) and Date(s)

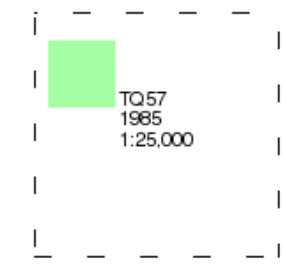

Russian Map - Slice A

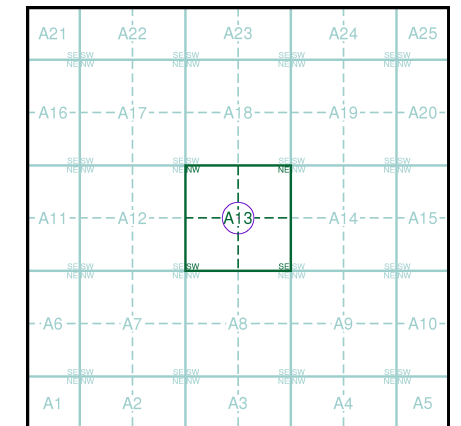

Order Details

Order Number: 159410216\_1\_1  
 Customer Ref: 42230  
 National Grid Reference: 551940, 177490  
 Slice: A  
 Site Area (Ha): 0.01  
 Search Buffer (m): 1000

Site Details

Larger Extent



Tel: 0844 844 9952  
 Fax: 0844 844 9951  
 Web: www.envirocheck.co.uk



**Ordnance Survey Plan**

**Published 1987**

**Source map scale - 1:10,000**

The historical maps shown were reproduced from maps predominantly held at the scale adopted for England, Wales and Scotland in the 1840's. In 1854 the 1:2,500 scale was adopted for mapping urban areas; these maps were used to update the 1:10,560 maps. The published date given therefore is often some years later than the surveyed date. Before 1938, all OS maps were based on the Cassini Projection, with independent surveys of a single county or group of counties, giving rise to significant inaccuracies in outlying areas. In the late 1940's, a Provisional Edition was produced, which updated the 1:10,560 mapping from a number of sources. The maps appear unfinished - with all military camps and other strategic sites removed. These maps were initially overprinted with the National Grid. In 1970, the first 1:10,000 maps were produced using the Transverse Mercator Projection. The revision process continued until recently, with new editions appearing every 10 years or so for urban areas.

**Map Name(s) and Date(s)**

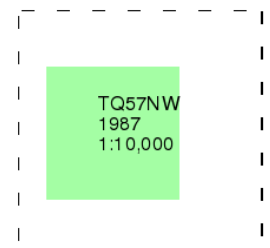

**Historical Map - Slice A**

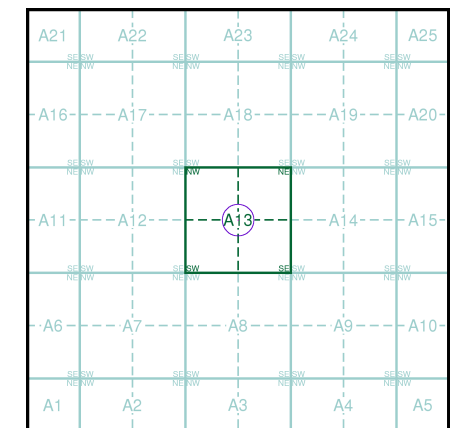

**Order Details**

Order Number: 159410216\_1\_1  
 Customer Ref: 42230  
 National Grid Reference: 551940, 177490  
 Slice: A  
 Site Area (Ha): 0.01  
 Search Buffer (m): 1000

**Site Details**

Larger Extent



Tel: 0844 844 9952  
 Fax: 0844 844 9951  
 Web: www.envirocheck.co.uk



### Ordnance Survey Plan

Published 1996

Source map scale - 1:10,000

The historical maps shown were reproduced from maps predominantly held at the scale adopted for England, Wales and Scotland in the 1840's. In 1854 the 1:2,500 scale was adopted for mapping urban areas; these maps were used to update the 1:10,560 maps. The published date given therefore is often some years later than the surveyed date. Before 1938, all OS maps were based on the Cassini Projection, with independent surveys of a single county or group of counties, giving rise to significant inaccuracies in outlying areas. In the late 1940's, a Provisional Edition was produced, which updated the 1:10,560 mapping from a number of sources. The maps appear unfinished - with all military camps and other strategic sites removed. These maps were initially overprinted with the National Grid. In 1970, the first 1:10,000 maps were produced using the Transverse Mercator Projection. The revision process continued until recently, with new editions appearing every 10 years or so for urban areas.

### Map Name(s) and Date(s)

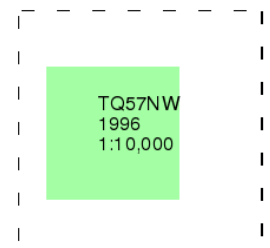

### Historical Map - Slice A

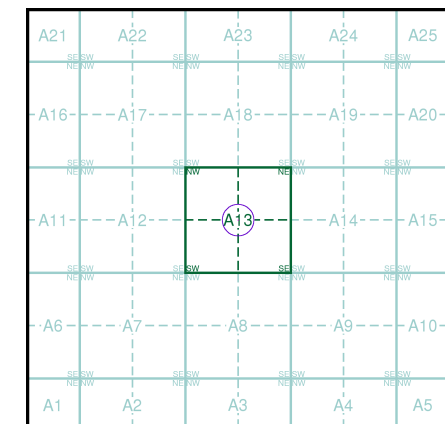

### Order Details

Order Number: 159410216\_1\_1  
 Customer Ref: 42230  
 National Grid Reference: 551940, 177490  
 Slice: A  
 Site Area (Ha): 0.01  
 Search Buffer (m): 1000

### Site Details

Larger Extent



Tel: 0844 844 9952  
 Fax: 0844 844 9951  
 Web: www.envirocheck.co.uk



© Crown copyright. All Rights Reserved. Licence Number 100022432.



## 10k Raster Mapping

Published 1999

Source map scale - 1:10,000

The historical maps shown were produced from the Ordnance Survey's 1:10,000 colour raster mapping. These maps are derived from Landplan which replaced the old 1:10,000 maps originally published in 1970. The data is highly detailed showing buildings, fences and field boundaries as well as all roads, tracks and paths. Road names are also included together with the relevant road number and classification. Boundary information depiction includes county, unitary authority, district, civil parish and constituency.

### Map Name(s) and Date(s)

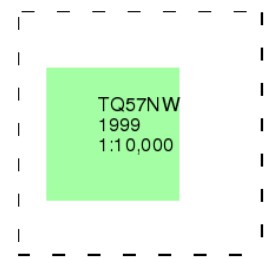

### Historical Map - Slice A

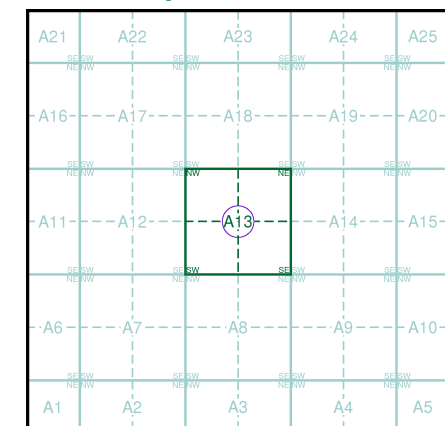

### Order Details

Order Number: 159410216\_1\_1  
 Customer Ref: 42230  
 National Grid Reference: 551940, 177490  
 Slice: A  
 Site Area (Ha): 0.01  
 Search Buffer (m): 1000

### Site Details

Larger Extent



Tel: 0844 844 9952  
 Fax: 0844 844 9951  
 Web: www.envirocheck.co.uk



## 10k Raster Mapping

Published 2006

Source map scale - 1:10,000

The historical maps shown were produced from the Ordnance Survey's 1:10,000 colour raster mapping. These maps are derived from Landplan which replaced the old 1:10,000 maps originally published in 1970. The data is highly detailed showing buildings, fences and field boundaries as well as all roads, tracks and paths. Road names are also included together with the relevant road number and classification. Boundary information depiction includes county, unitary authority, district, civil parish and constituency.

### Map Name(s) and Date(s)

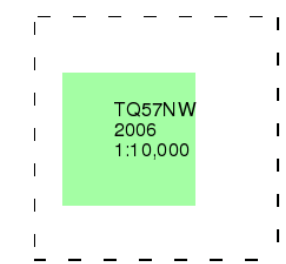

### Historical Map - Slice A

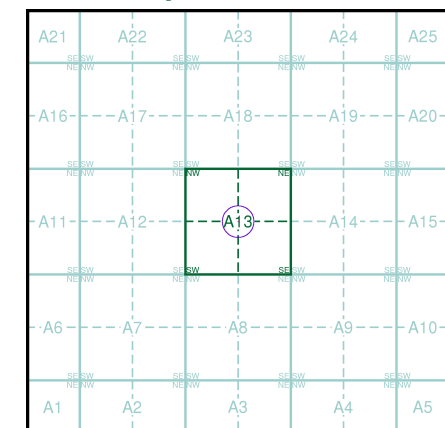

### Order Details

Order Number: 159410216\_1\_1  
 Customer Ref: 42230  
 National Grid Reference: 551940, 177490  
 Slice: A  
 Site Area (Ha): 0.01  
 Search Buffer (m): 1000

### Site Details

Larger Extent



Tel: 0844 844 9952  
 Fax: 0844 844 9951  
 Web: www.envirocheck.co.uk



© Crown copyright. All Rights Reserved. Licence Number 10002432.



**VectorMap Local**  
**Published 2018**  
**Source map scale - 1:10,000**

VectorMap Local (Raster) is Ordnance Survey's highest detailed 'backdrop' mapping product. These maps are produced from OS's VectorMap Local, a simple vector dataset at a nominal scale of 1:10,000, covering the whole of Great Britain, that has been designed for creating graphical mapping. OS VectorMap Local is derived from large-scale information surveyed at 1:1250 scale (covering major towns and cities), 1:2500 scale (smaller towns, villages and developed rural areas), and 1:10 000 scale (mountain, moorland and river estuary areas).

**Map Name(s) and Date(s)**

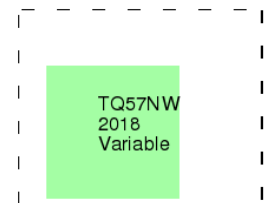

**Historical Map - Slice A**

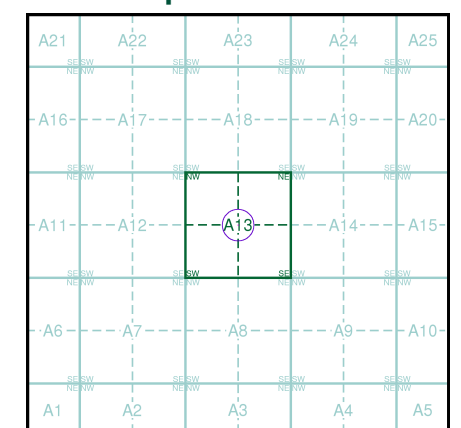

**Order Details**

Order Number: 159410216\_1\_1  
 Customer Ref: 42230  
 National Grid Reference: 551940, 177490  
 Slice: A  
 Site Area (Ha): 0.01  
 Search Buffer (m): 1000

**Site Details**

Larger Extent



Tel: 0844 844 9952  
 Fax: 0844 844 9951  
 Web: www.envirocheck.co.uk



# Historical Mapping Legends

## Ordnance Survey County Series 1:10,560

- Gravel Pit
- Sand Pit
- Other Pits
- Quarry
- Shingle
- Orchard
- Osiers
- Reeds
- Marsh
- Mixed Wood
- Deciduous
- Brushwood
- Fir
- Furze
- Rough Pasture
- Arrow denotes flow of water
- Trigonometrical Station
- Site of Antiquities
- Bench Mark
- Pump, Guide Post, Signal Post
- Well, Spring, Boundary Post
- 285** Surface Level
- Sketched Contour
- Instrumental Contour
- Main Roads
- Minor Roads
- Sunken Road
- Raised Road
- Road over Railway
- Railway over River
- Railway over Road
- Level Crossing
- Road over River or Canal
- Road over Stream
- Road over Stream
- County Boundary (Geographical)
- County & Civil Parish Boundary
- Administrative County & Civil Parish Boundary
- County Borough Boundary (England)
- County Burgh Boundary (Scotland)
- Rural District Boundary
- Civil Parish Boundary

## Ordnance Survey Plan 1:10,000

- Chalk Pit, Clay Pit or Quarry
- Gravel Pit
- Sand Pit
- Disused Pit or Quarry
- Refuse or Slag Heap
- Lake, Loch or Pond
- Dunes
- Boulders
- Coniferous Trees
- Non-Coniferous Trees
- Orchard
- Scrub
- Coppice
- Bracken
- Heath
- Rough Grassland
- Marsh
- Reeds
- Saltings
- Building
- Glasshouse
- Sloping Masonry
- Pylon
- Electricity Transmission Line
- Pole
- Cutting
- Embankment
- Standard Gauge Multiple Track
- Standard Gauge Single Track
- Siding, Tramway or Mineral Line
- Narrow Gauge
- Geographical County
- Administrative County, County Borough or County of City
- Municipal Borough, Urban or Rural District, Burgh or District Council
- Borough, Burgh or County Constituency  
Shown only when not coincident with other boundaries
- Civil Parish  
Shown alternately when coincidence of boundaries occurs
- BP, BS Boundary Post or Stone
- Ch Church
- CH Club House
- F E Sta Fire Engine Station
- FB Foot Bridge
- Fn Fountain
- GP Guide Post
- MP Mile Post
- MS Mile Stone
- Pol Sta Police Station
- PO Post Office
- PC Public Convenience
- PH Public House
- SB Signal Box
- Spr Spring
- TCB Telephone Call Box
- TCP Telephone Call Post
- W Well

## 1:10,000 Raster Mapping

- Gravel Pit
- Rock
- Boulders
- Shingle
- Sand
- Slopes
- General detail
- Overhead detail
- Multi-track railway
- County boundary (England only)
- District, Unitary, Metropolitan, London Borough boundary
- Area of wooded vegetation
- Non-coniferous trees
- Coniferous trees
- Orchard
- Rough Grassland
- Scrub
- Water feature
- MHW(S) Mean high water (springs)
- Telephone line (where shown)
- Bench mark (where shown)
- Point feature (e.g. Guide Post or Mile Stone)
- Site of (antiquity)
- General Building
- Refuse tip or slag heap
- Rock (scattered)
- Boulders (scattered)
- Mud
- Sand Pit
- Top of cliff
- Underground detail
- Narrow gauge railway
- Single track railway
- Civil, parish or community boundary
- Constituency boundary
- Non-coniferous trees
- Coniferous trees
- Positioned tree
- Coppice or Osiers
- Heath
- Marsh, Salt Marsh or Reeds
- Flow arrows
- MLW(S) Mean low water (springs)
- Electricity transmission line (with poles)
- Triangulation station
- Pylon, flare stack or lighting tower
- Glasshouse
- Important Building



## Historical Mapping & Photography included:

Mapping Type	Scale	Date	Pg
Kent	1:10,560	1869	3
Essex	1:10,560	1873	4
Kent	1:10,560	1898	5
Essex	1:10,560	1899	6
Kent	1:10,560	1910	7
London	1:10,560	1920	8
Essex	1:10,560	1921	9
Kent	1:10,560	1931	10
Kent	1:10,560	1938	11
London	1:10,560	1938	12
Essex	1:10,560	1938	13
Kent	1:10,560	1939 - 1950	14
<b>Historical Aerial Photography</b>			
Ordnance Survey Plan	1:10,000	1961	16
Ordnance Survey Plan	1:10,000	1966 - 1967	17
Ordnance Survey Plan	1:10,000	1975	18
Gravesend	1:10,000	1977	19
Ordnance Survey Plan	1:10,000	1983 - 1987	20
London	1:25,000	1985	21
Ordnance Survey Plan	1:10,000	1996	22
10K Raster Mapping	1:10,000	1999	23
10K Raster Mapping	1:10,000	2006	24
VectorMap Local	1:10,000	2018	25

## Historical Map - Slice A

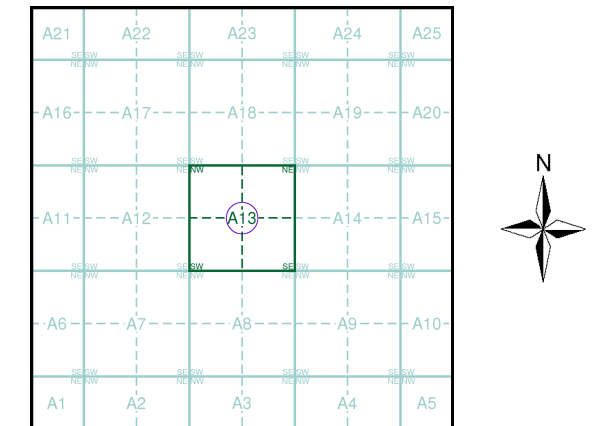

## Order Details

Order Number: 159450246\_1\_1  
 Customer Ref: 552670, 175354  
 National Grid Reference: 552670, 175350  
 Slice: A  
 Site Area (Ha): 0.01  
 Search Buffer (m): 1000

## Site Details

552670, 175354



Tel: 0844 844 9952  
 Fax: 0844 844 9951  
 Web: www.envirocheck.co.uk

# Russian Military Mapping Legends

## 1:5,000 and 1:10,000 mapping

a. Not drawn to scale b. Drawn to scale

	Government and Administrative Buildings		Military and Industrial Buildings
	Military and Communication Areas		Subway Entrance
	Fireproof Building		Prominent Fireproof Building
	Non-fireproof Building		Non-fireproof Building (non-dwelling)
	Factory, mill, and flour mill, with chimneys		Factory, mill, and flour mill, without chimneys
	Power Station, drawn to scale		Hydroelectric Power Station
	Radio Station, drawn to scale		Telephone Station, drawn to scale
	Abandoned Open-pit Mine or Quarry		Open-pit Salt Mine
	Pit		Oil Deposit or Well
	Oil Seepage		Natural Gas Tank
	Tailings Pile		Fuel Storage Tanks
	Bench Mark		Drill Hole
	Burial Mound		Triangulation Point on Burial Mound
	Single-track Railroad		Double-track Railroad
	Railroad and Station Building		Small Bridge
	Pipe (Culvert)		Tunnel
	Coniferous Forest		Deciduous Forest
	Mixed Forest		Lawns
	Citrus Orchard		Wet Ground
	Scattered Vegetation		

**243,8** Values for prominent elevations  
**186.0** Numbers for spot elevations, depth soundings, contour lines, etc.  
**0,2** Velocity of the current, width of river bed, depth of river  
**180/12** Fractional terms: length and capacity of bridges; depth of fords and condition of the river bottom; height of forest and the diameter of trees

### Russian Alphabet (For reference and phonetic interpretation of map text)

<b>А а (A)</b>	<b>З з (Z)</b>	<b>П п (P)</b>	<b>Ч ч (CH)</b>
<b>Б б (B)</b>	<b>И и (I)</b>	<b>Р р (R)</b>	<b>Ш ш (SH)</b>
<b>В в (V)</b>	<b>Й й (Y)</b>	<b>С с (S)</b>	<b>Щ щ (SHCH)</b>
<b>Г г (G)</b>	<b>К к (K)</b>	<b>Т т (T)</b>	<b>Ъ (-)</b>
<b>Д д (D)</b>	<b>Л л (L)</b>	<b>У у (U)</b>	<b>Ы (Y)</b>
<b>Е е (E)</b>	<b>М м (M)</b>	<b>Ф ф (F)</b>	<b>Ь (')</b>
<b>Ё ё (YO)</b>	<b>Н н (N)</b>	<b>Х х (KH)</b>	<b>Э э (E)</b>
<b>Ж ж (ZH)</b>	<b>О о (O)</b>	<b>Ц ц (TS)</b>	<b>Ю ю (YU or IU)</b>
			<b>Я я (YA or IA)</b>

## 1:25,000 mapping

a. Not drawn to scale b. Drawn to scale

	Government and Administrative Buildings		Military and Industrial Buildings
	Military and Communication Areas		Subway Entrance
	Partly Demolished Buildings		Demolished Buildings
	Built-Up Area with Fireproof Buildings Predominant		Built-Up Area with Non-Fireproof Buildings Predominant
	Individual Fireproof Building		Prominent Industrial Building
	Individual Dwelling, Fireproof		Ruins of an Individual Dwelling
	Factory or Mill Chimney		Factory or Mill with Chimney
	Factory or Mill without Chimney		Salt Mine
	Mine or Open Pit Mine		Tailings Pile
	Operating Shaft or Mine		Non-Operating Shaft or Mine
	Pit		Gas Pump or Service Station
	Fuel Storage or Natural Gas Tank		Oil or Natural Gas Derrick
	Small Hydroelectric Power Station		Power Station
	Transformer Station		Cemetery
	Burial Mound (height in metres)		Triangulation Point on Burial Mound
	Triangulation Point		Bench Mark
	Bench Mark (monumented)		Telegraph Office
	Telephone Station		Radio Station
	Radio Tower		Airfield or Seaplane Base
	Landing Strip		Cut
	Fill		Km Post
	Plantings		Width of Road
	Steep Grade		Highway under Construction
	Improved Dirt Road (former truck road)		Small Bridge
	Pipe (Culvert)		Tunnel
	Dismantled Railroad		Double-track Railroad with First Class Station
	Railroad Under Construction		Shore Embankment
	River or Ditch with Embankment		Water Gauge
	Direction and velocity of current		Water Level Mark
	Well		Spring
	Water Reservoir or Rain Water Pit		Isobath with value
	Heavy (Index) Contour Line		Half Contour Line
	Contour Line and Value		Spot Elevation Value
	Coniferous		Deciduous
	Mixed		Scrub

## Key to Numbers on Mapping

### TQ57\_London

No.	Description
43	Depot (Railway)
225	Factory (Electrical Appliances)
328	Printing House



## Historical Mapping & Photography included:

Mapping Type	Scale	Date	Pg
Kent	1:10,560	1869	3
Essex	1:10,560	1873	4
Kent	1:10,560	1898	5
Essex	1:10,560	1899	6
Kent	1:10,560	1910	7
London	1:10,560	1920	8
Essex	1:10,560	1921	9
Kent	1:10,560	1931	10
Kent	1:10,560	1938	11
London	1:10,560	1938	12
Essex	1:10,560	1938	13
Kent	1:10,560	1939 - 1950	14
Historical Aerial Photography	1:10,560	1947 - 1948	15
Ordnance Survey Plan	1:10,000	1961	16
Ordnance Survey Plan	1:10,000	1966 - 1967	17
Ordnance Survey Plan	1:10,000	1975	18
Gravesend	1:10,000	1977	19
Ordnance Survey Plan	1:10,000	1983 - 1987	20
London	1:25,000	1985	21
Ordnance Survey Plan	1:10,000	1996	22
10K Raster Mapping	1:10,000	1999	23
10K Raster Mapping	1:10,000	2006	24
VectorMap Local	1:10,000	2018	25

## Russian Map - Slice A

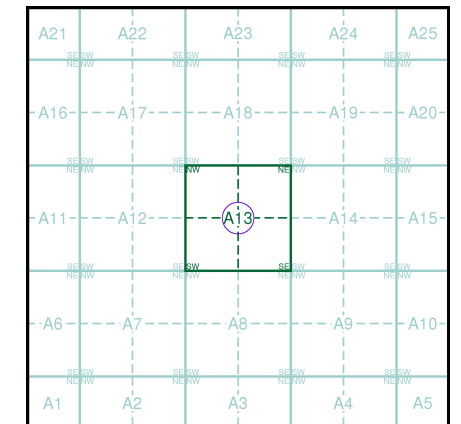

## Order Details

Order Number: 159450246\_1\_1  
 Customer Ref: 552670, 175354  
 National Grid Reference: 552670, 175350  
 Slice: A  
 Site Area (Ha): 0.01  
 Search Buffer (m): 1000

## Site Details

552670, 175354



Tel: 0844 844 9952  
 Fax: 0844 844 9951  
 Web: www.envirocheck.co.uk

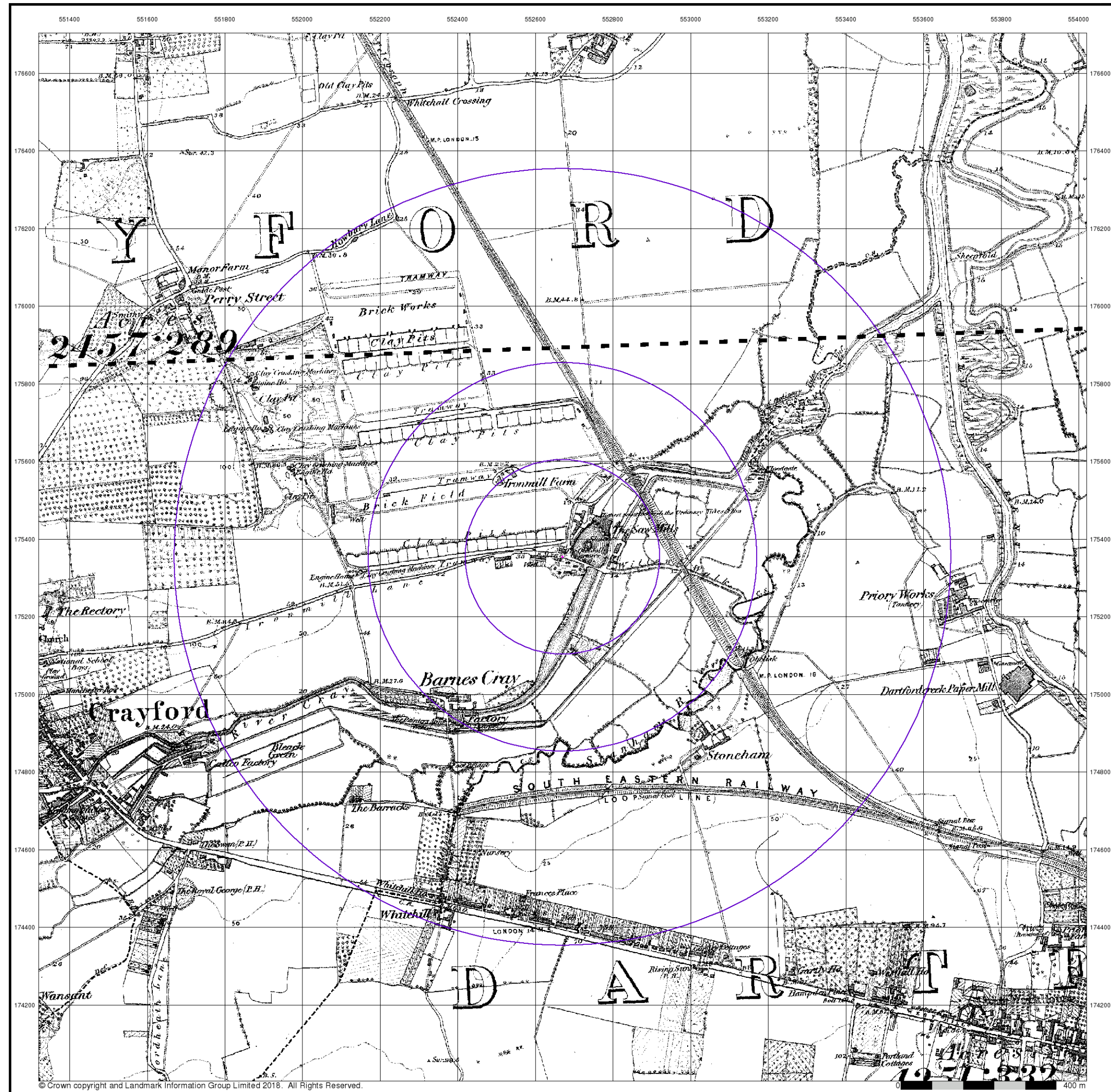

**Kent**

**Published 1869**

**Source map scale - 1:10,560**

The historical maps shown were reproduced from maps predominantly held at the scale adopted for England, Wales and Scotland in the 1840's. In 1854 the 1:2,500 scale was adopted for mapping urban areas; these maps were used to update the 1:10,560 maps. The published date given therefore is often some years later than the surveyed date. Before 1938, all OS maps were based on the Cassini Projection, with independent surveys of a single county or group of counties, giving rise to significant inaccuracies in outlying areas. In the late 1940's, a Provisional Edition was produced, which updated the 1:10,560 mapping from a number of sources. The maps appear unfinished - with all military camps and other strategic sites removed. These maps were initially overprinted with the National Grid. In 1970, the first 1:10,000 maps were produced using the Transverse Mercator Projection. The revision process continued until recently, with new editions appearing every 10 years or so for urban areas.

**Map Name(s) and Date(s)**

00300	1869	1:10,560
00900	1869	1:10,560

**Historical Map - Slice A**

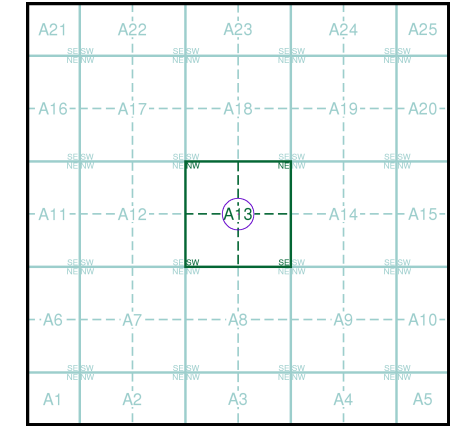

**Order Details**

Order Number: 159450246\_1\_1  
 Customer Ref: 552670, 175354  
 National Grid Reference: 552670, 175350  
 Slice: A  
 Site Area (Ha): 0.01  
 Search Buffer (m): 1000

**Site Details**

552670, 175354



Tel: 0844 844 9952  
 Fax: 0844 844 9951  
 Web: www.envirocheck.co.uk

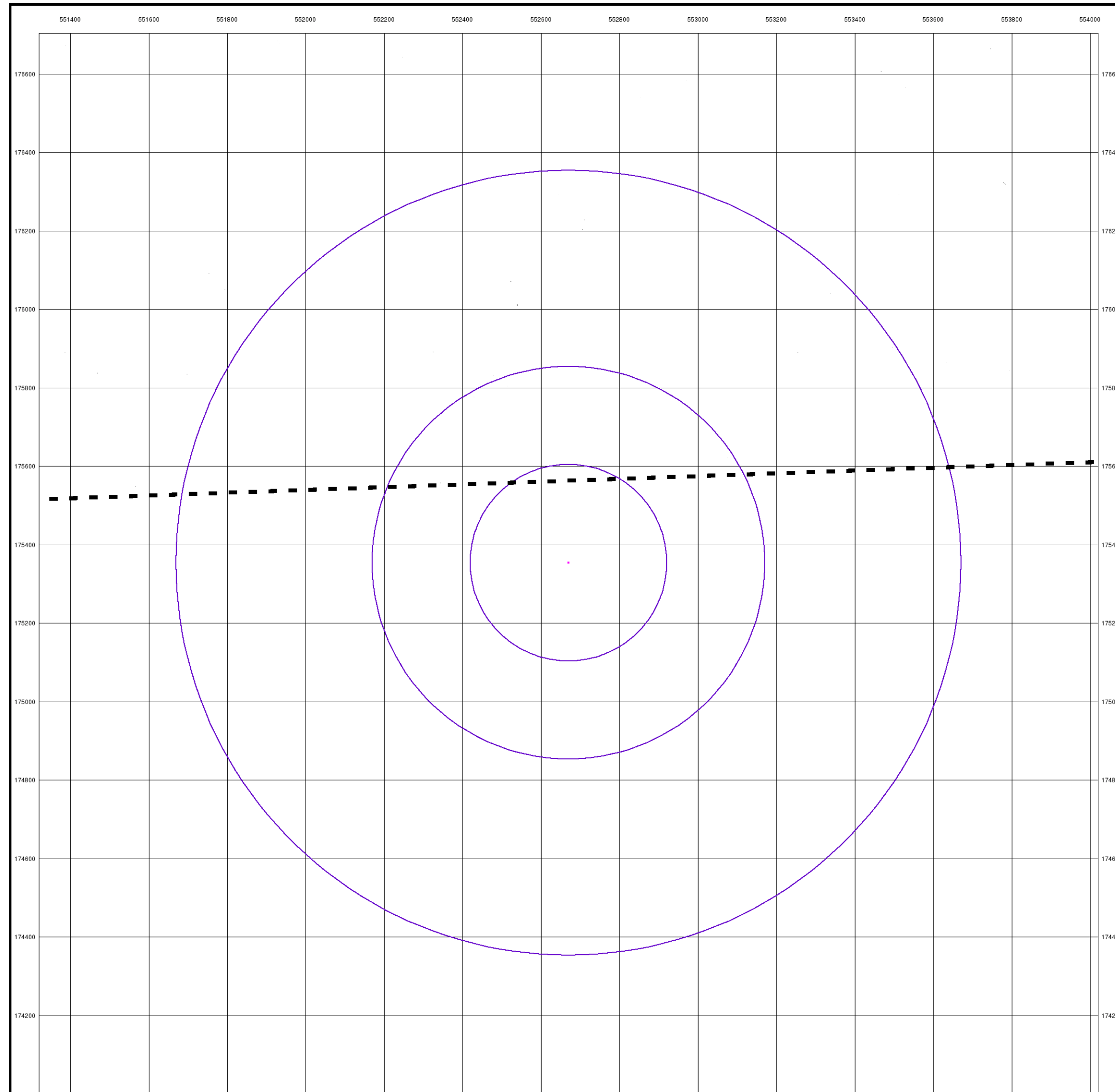

**Essex**

**Published 1873**

**Source map scale - 1:10,560**

The historical maps shown were reproduced from maps predominantly held at the scale adopted for England, Wales and Scotland in the 1840's. In 1854 the 1:2,500 scale was adopted for mapping urban areas; these maps were used to update the 1:10,560 maps. The published date given therefore is often some years later than the surveyed date. Before 1938, all OS maps were based on the Cassini Projection, with independent surveys of a single county or group of counties, giving rise to significant inaccuracies in outlying areas. In the late 1940's, a Provisional Edition was produced, which updated the 1:10,560 mapping from a number of sources. The maps appear unfinished - with all military camps and other strategic sites removed. These maps were initially overprinted with the National Grid. In 1970, the first 1:10,000 maps were produced using the Transverse Mercator Projection. The revision process continued until recently, with new editions appearing every 10 years or so for urban areas.

**Map Name(s) and Date(s)**

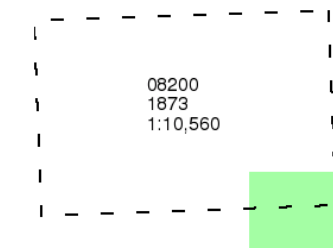

**Historical Map - Slice A**

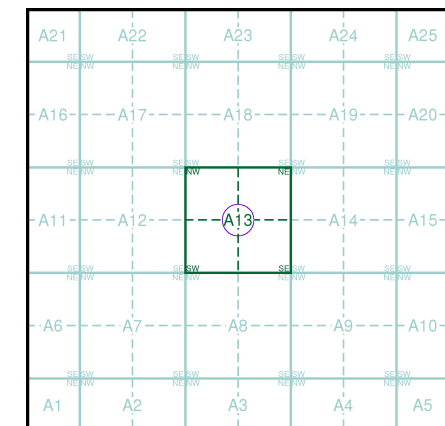

**Order Details**

Order Number: 159450246\_1\_1  
 Customer Ref: 552670, 175354  
 National Grid Reference: 552670, 175350  
 Slice: A  
 Site Area (Ha): 0.01  
 Search Buffer (m): 1000

**Site Details**

552670, 175354



Tel: 0844 844 9952  
 Fax: 0844 844 9951  
 Web: www.envirocheck.co.uk

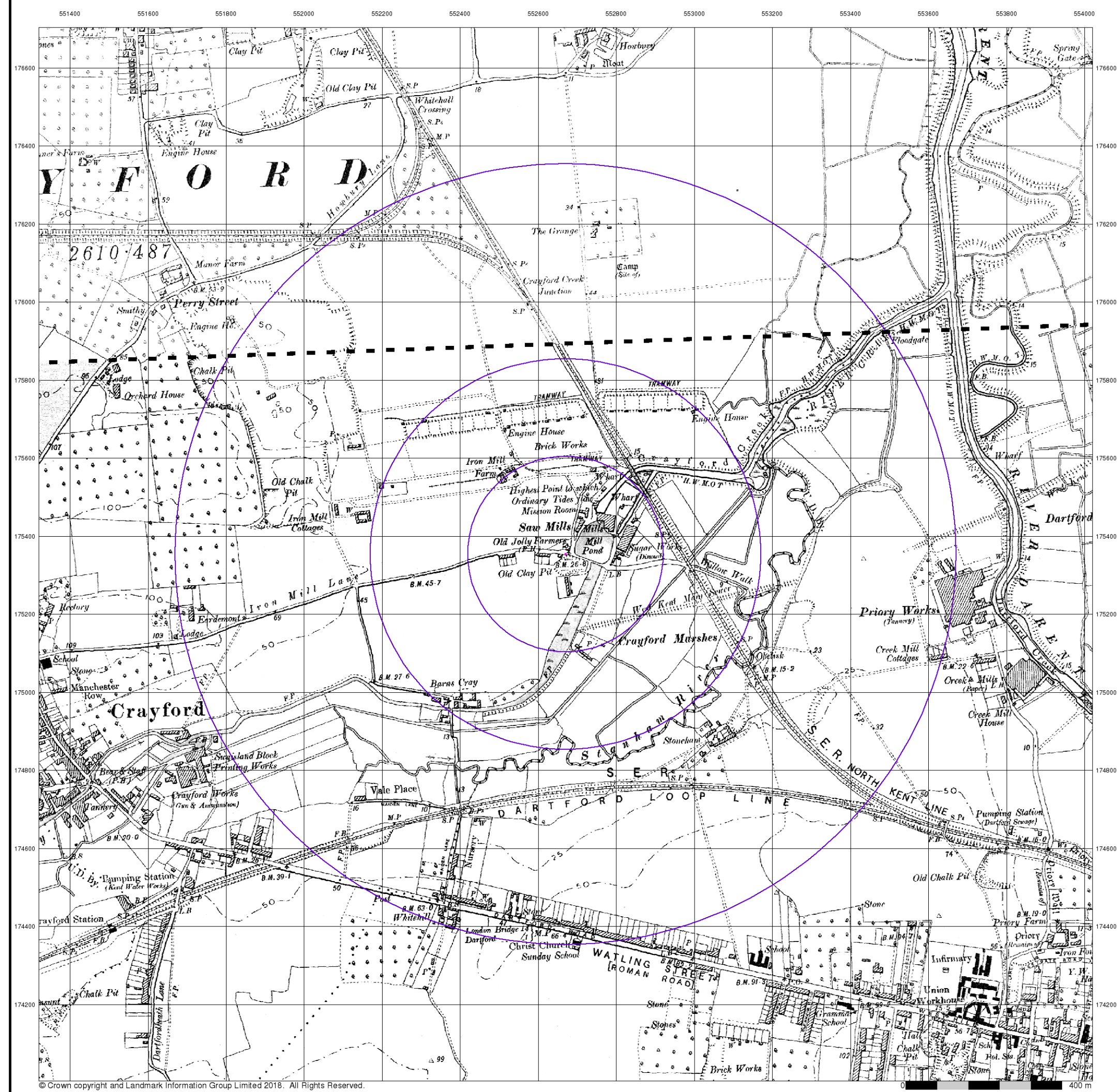

**Kent**

**Published 1898**

**Source map scale - 1:10,560**

The historical maps shown were reproduced from maps predominantly held at the scale adopted for England, Wales and Scotland in the 1840's. In 1854 the 1:2,500 scale was adopted for mapping urban areas; these maps were used to update the 1:10,560 maps. The published date given therefore is often some years later than the surveyed date. Before 1938, all OS maps were based on the Cassini Projection, with independent surveys of a single county or group of counties, giving rise to significant inaccuracies in outlying areas. In the late 1940's, a Provisional Edition was produced, which updated the 1:10,560 mapping from a number of sources. The maps appear unfinished - with all military camps and other strategic sites removed. These maps were initially overprinted with the National Grid. In 1970, the first 1:10,000 maps were produced using the Transverse Mercator Projection. The revision process continued until recently, with new editions appearing every 10 years or so for urban areas.

**Map Name(s) and Date(s)**

003SW	1898	1:10,560
009NW	1898	1:10,560

**Historical Map - Slice A**

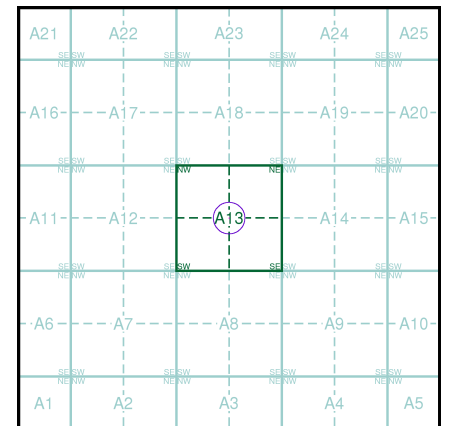

**Order Details**

Order Number: 159450246\_1\_1  
 Customer Ref: 552670, 175354  
 National Grid Reference: 552670, 175350  
 Slice: A  
 Site Area (Ha): 0.01  
 Search Buffer (m): 1000

**Site Details**

552670, 175354



Tel: 0844 844 9952  
 Fax: 0844 844 9951  
 Web: www.envirocheck.co.uk



**Essex**

**Published 1899**

**Source map scale - 1:10,560**

The historical maps shown were reproduced from maps predominantly held at the scale adopted for England, Wales and Scotland in the 1840's. In 1854 the 1:2,500 scale was adopted for mapping urban areas; these maps were used to update the 1:10,560 maps. The published date given therefore is often some years later than the surveyed date. Before 1938, all OS maps were based on the Cassini Projection, with independent surveys of a single county or group of counties, giving rise to significant inaccuracies in outlying areas. In the late 1940's, a Provisional Edition was produced, which updated the 1:10,560 mapping from a number of sources. The maps appear unfinished - with all military camps and other strategic sites removed. These maps were initially overprinted with the National Grid. In 1970, the first 1:10,000 maps were produced using the Transverse Mercator Projection. The revision process continued until recently, with new editions appearing every 10 years or so for urban areas.

**Map Name(s) and Date(s)**

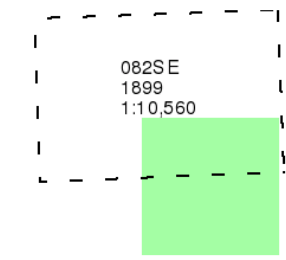

**Historical Map - Slice A**

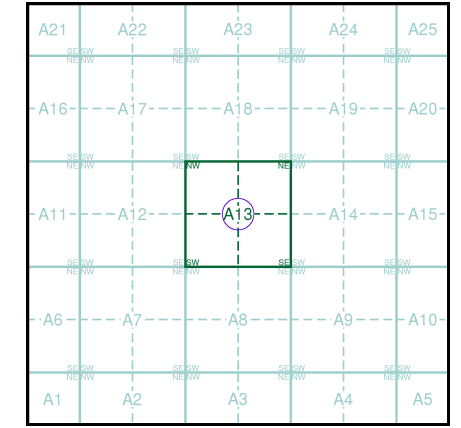

**Order Details**

Order Number: 159450246\_1\_1  
 Customer Ref: 552670, 175354  
 National Grid Reference: 552670, 175350  
 Slice: A  
 Site Area (Ha): 0.01  
 Search Buffer (m): 1000

**Site Details**

552670, 175354



Tel: 0844 844 9952  
 Fax: 0844 844 9951  
 Web: www.envirocheck.co.uk

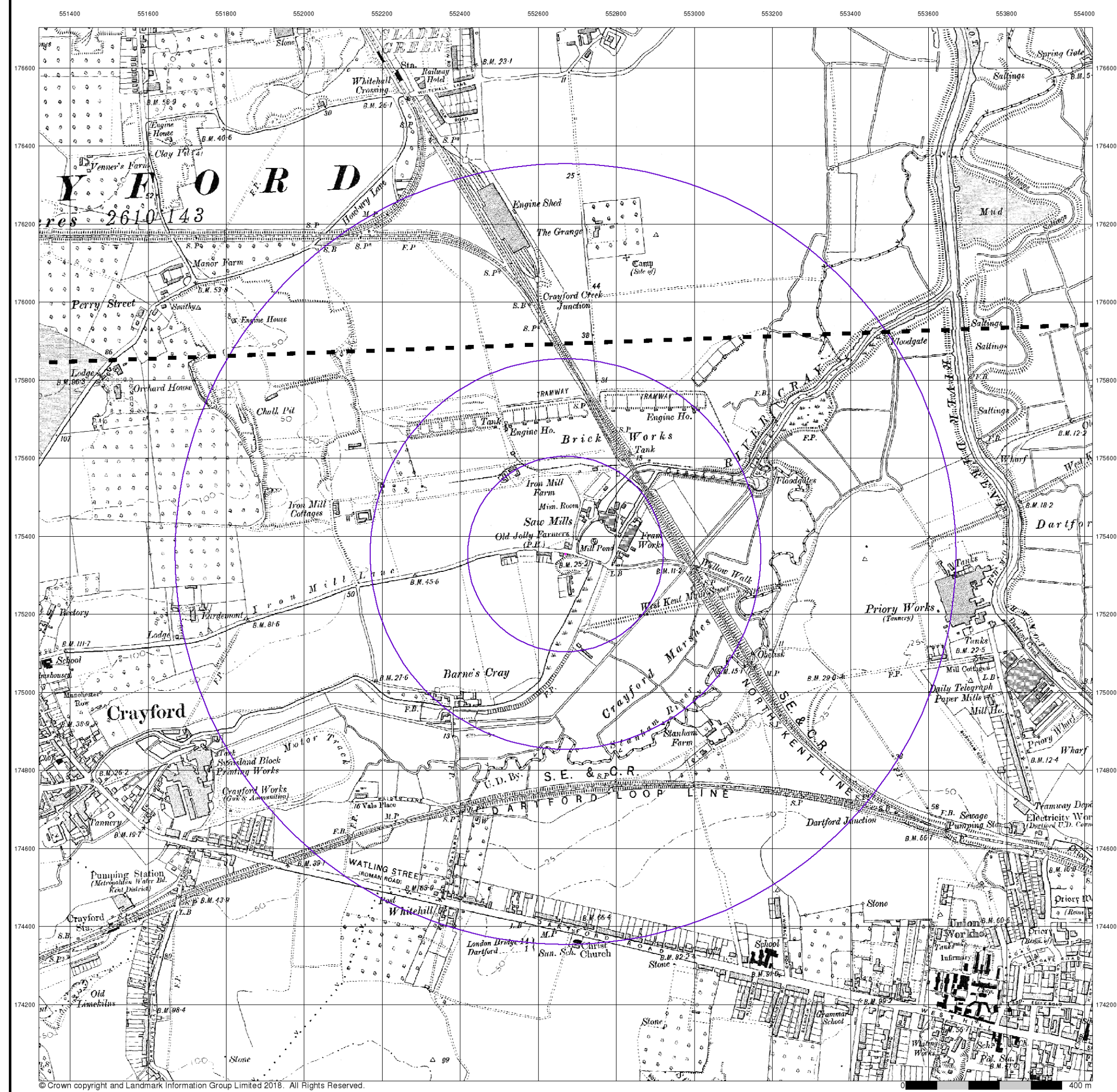

**Kent**

**Published 1910**

**Source map scale - 1:10,560**

The historical maps shown were reproduced from maps predominantly held at the scale adopted for England, Wales and Scotland in the 1840's. In 1854 the 1:2,500 scale was adopted for mapping urban areas; these maps were used to update the 1:10,560 maps. The published date given therefore is often some years later than the surveyed date. Before 1938, all OS maps were based on the Cassini Projection, with independent surveys of a single county or group of counties, giving rise to significant inaccuracies in outlying areas. In the late 1940's, a Provisional Edition was produced, which updated the 1:10,560 mapping from a number of sources. The maps appear unfinished - with all military camps and other strategic sites removed. These maps were initially overprinted with the National Grid. In 1970, the first 1:10,000 maps were produced using the Transverse Mercator Projection. The revision process continued until recently, with new editions appearing every 10 years or so for urban areas.

**Map Name(s) and Date(s)**

003SW	1910	1:10,560
009NW	1910	1:10,560

**Historical Map - Slice A**

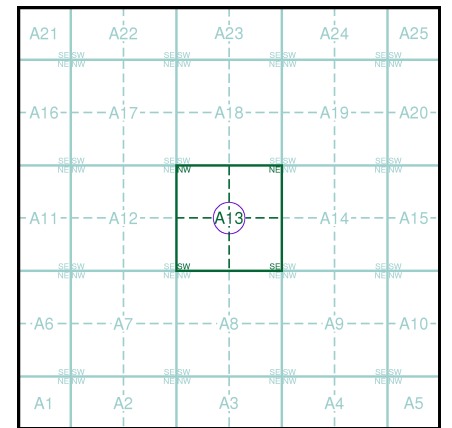

**Order Details**

Order Number: 159450246\_1\_1  
 Customer Ref: 552670, 175354  
 National Grid Reference: 552670, 175350  
 Slice: A  
 Site Area (Ha): 0.01  
 Search Buffer (m): 1000

**Site Details**

552670, 175354



Tel: 0844 844 9952  
 Fax: 0844 844 9951  
 Web: www.envirocheck.co.uk

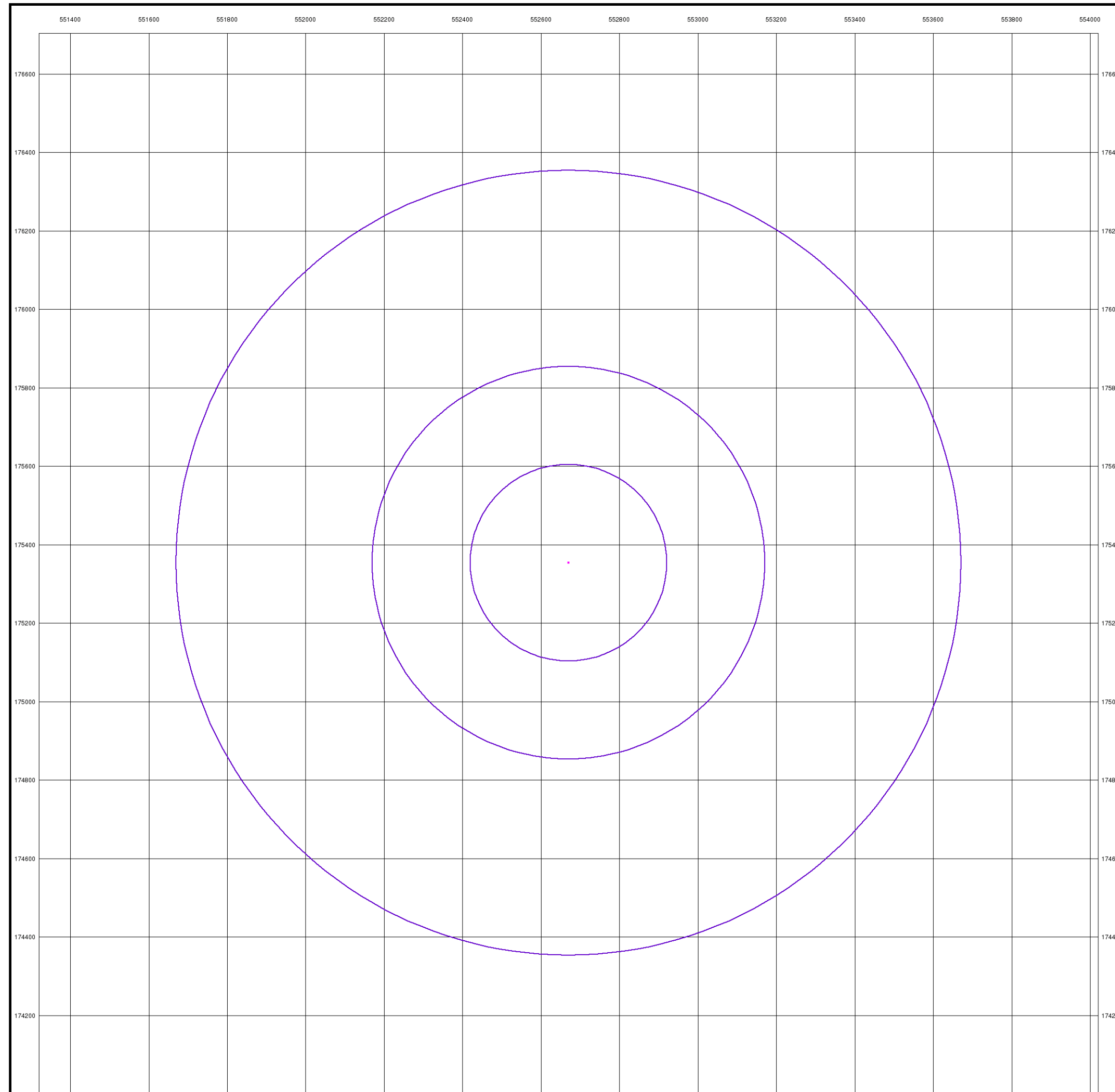

**London**

**Published 1920**

**Source map scale - 1:10,560**

The historical maps shown were reproduced from maps predominantly held at the scale adopted for England, Wales and Scotland in the 1840's. In 1854 the 1:2,500 scale was adopted for mapping urban areas; these maps were used to update the 1:10,560 maps. The published date given therefore is often some years later than the surveyed date. Before 1938, all OS maps were based on the Cassini Projection, with independent surveys of a single county or group of counties, giving rise to significant inaccuracies in outlying areas. In the late 1940's, a Provisional Edition was produced, which updated the 1:10,560 mapping from a number of sources. The maps appear unfinished - with all military camps and other strategic sites removed. These maps were initially overprinted with the National Grid. In 1970, the first 1:10,000 maps were produced using the Transverse Mercator Projection. The revision process continued until recently, with new editions appearing every 10 years or so for urban areas.

**Map Name(s) and Date(s)**

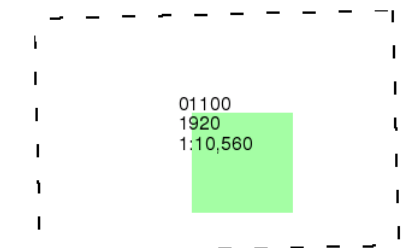

**Historical Map - Slice A**

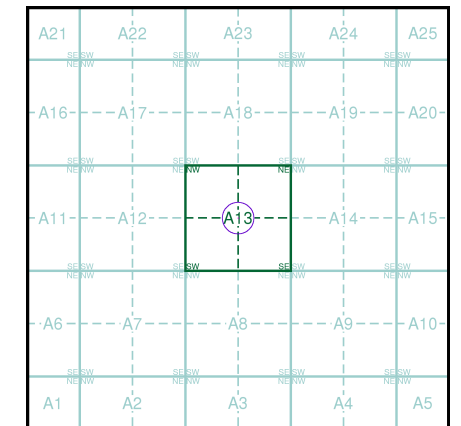

**Order Details**

Order Number: 159450246\_1\_1  
 Customer Ref: 552670, 175354  
 National Grid Reference: 552670, 175350  
 Slice: A  
 Site Area (Ha): 0.01  
 Search Buffer (m): 1000

**Site Details**

552670, 175354



Tel: 0844 844 9952  
 Fax: 0844 844 9951  
 Web: www.envirocheck.co.uk





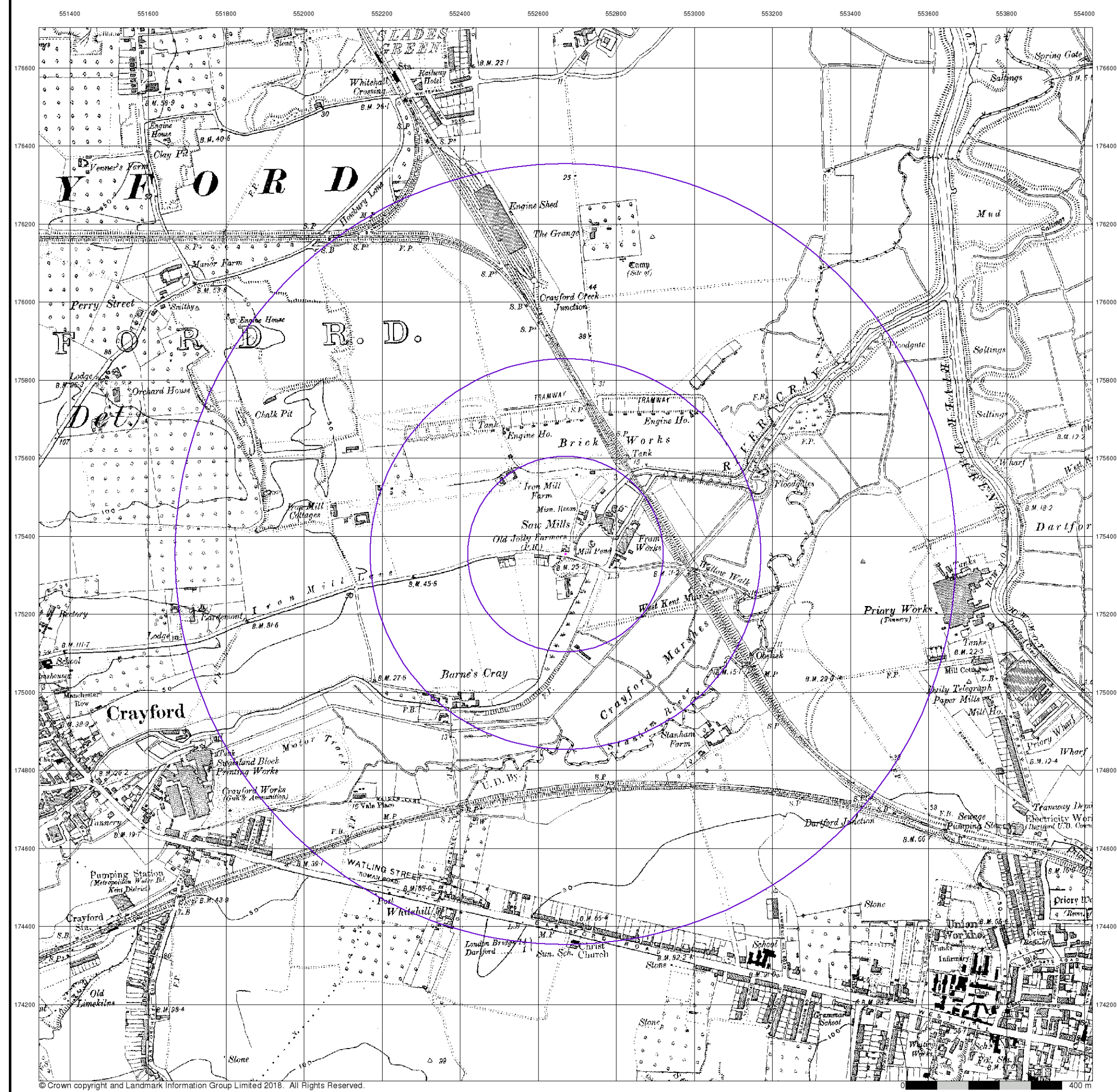

Essex

Published 1921

Source map scale - 1:10,560

The historical maps shown were reproduced from maps predominantly held at the scale adopted for England, Wales and Scotland in the 1840's. In 1854 the 1:2,500 scale was adopted for mapping urban areas; these maps were used to update the 1:10,560 maps. The published date given therefore is often some years later than the surveyed date. Before 1938, all OS maps were based on the Cassini Projection, with independent surveys of a single county or group of counties, giving rise to significant inaccuracies in outlying areas. In the late 1940's, a Provisional Edition was produced, which updated the 1:10,560 mapping from a number of sources. The maps appear unfinished - with all military camps and other strategic sites removed. These maps were initially overprinted with the National Grid. In 1970, the first 1:10,000 maps were produced using the Transverse Mercator Projection. The revision process continued until recently, with new editions appearing every 10 years or so for urban areas.

Map Name(s) and Date(s)

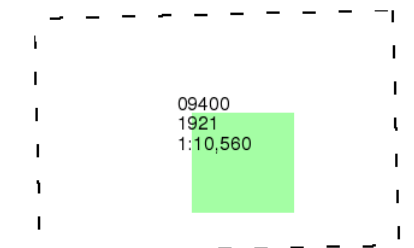

Historical Map - Slice A

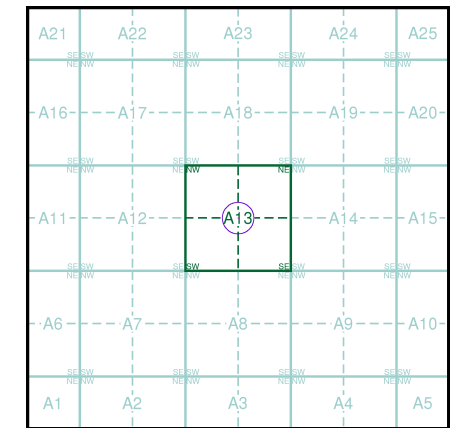

Order Details

Order Number: 159450246\_1\_1  
 Customer Ref: 552670, 175354  
 National Grid Reference: 552670, 175350  
 Slice: A  
 Site Area (Ha): 0.01  
 Search Buffer (m): 1000

Site Details

552670, 175354



Tel: 0844 844 9952  
 Fax: 0844 844 9951  
 Web: www.envirocheck.co.uk



**Kent**

**Published 1931**

**Source map scale - 1:10,560**

The historical maps shown were reproduced from maps predominantly held at the scale adopted for England, Wales and Scotland in the 1840's. In 1854 the 1:2,500 scale was adopted for mapping urban areas; these maps were used to update the 1:10,560 maps. The published date given therefore is often some years later than the surveyed date. Before 1938, all OS maps were based on the Cassini Projection, with independent surveys of a single county or group of counties, giving rise to significant inaccuracies in outlying areas. In the late 1940's, a Provisional Edition was produced, which updated the 1:10,560 mapping from a number of sources. The maps appear unfinished - with all military camps and other strategic sites removed. These maps were initially overprinted with the National Grid. In 1970, the first 1:10,000 maps were produced using the Transverse Mercator Projection. The revision process continued until recently, with new editions appearing every 10 years or so for urban areas.

**Map Name(s) and Date(s)**

003SW	1931	1:10,560
009NW	1931	1:10,560

**Historical Map - Slice A**

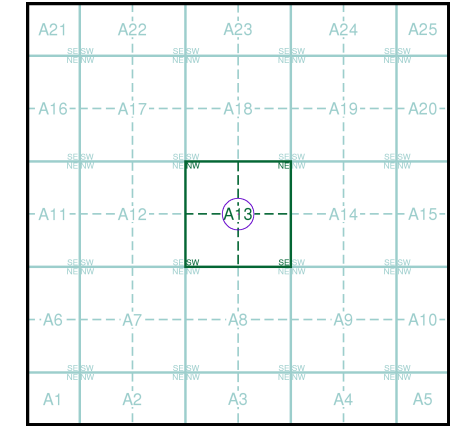

**Order Details**

Order Number: 159450246\_1\_1  
 Customer Ref: 552670, 175354  
 National Grid Reference: 552670, 175350  
 Slice: A  
 Site Area (Ha): 0.01  
 Search Buffer (m): 1000

**Site Details**

552670, 175354



Tel: 0844 844 9952  
 Fax: 0844 844 9951  
 Web: www.envirocheck.co.uk



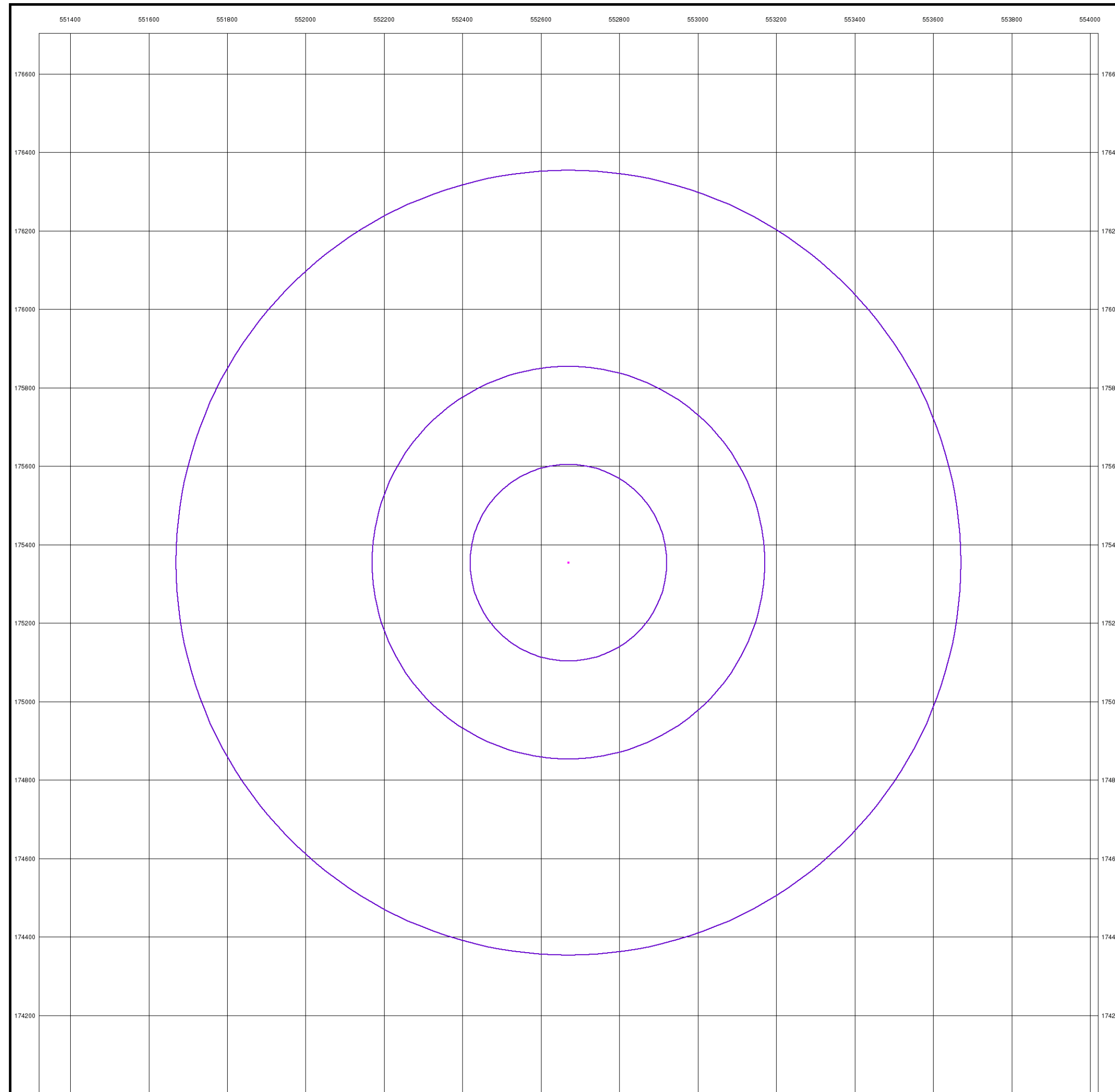

London

Published 1938

Source map scale - 1:10,560

The historical maps shown were reproduced from maps predominantly held at the scale adopted for England, Wales and Scotland in the 1840's. In 1854 the 1:2,500 scale was adopted for mapping urban areas; these maps were used to update the 1:10,560 maps. The published date given therefore is often some years later than the surveyed date. Before 1938, all OS maps were based on the Cassini Projection, with independent surveys of a single county or group of counties, giving rise to significant inaccuracies in outlying areas. In the late 1940's, a Provisional Edition was produced, which updated the 1:10,560 mapping from a number of sources. The maps appear unfinished - with all military camps and other strategic sites removed. These maps were initially overprinted with the National Grid. In 1970, the first 1:10,000 maps were produced using the Transverse Mercator Projection. The revision process continued until recently, with new editions appearing every 10 years or so for urban areas.

Map Name(s) and Date(s)

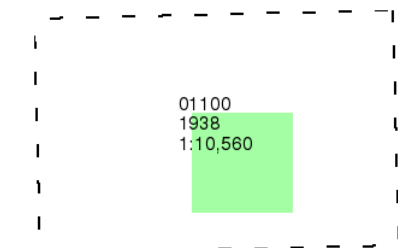

Historical Map - Slice A

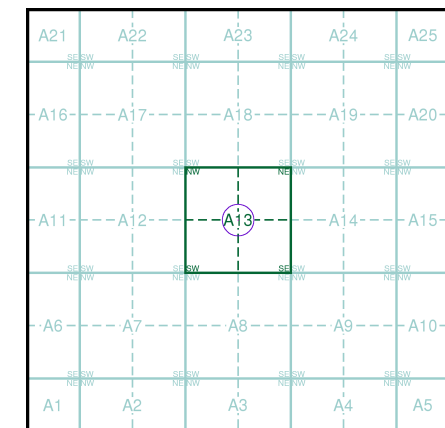

Order Details

Order Number: 159450246\_1\_1  
 Customer Ref: 552670, 175354  
 National Grid Reference: 552670, 175350  
 Slice: A  
 Site Area (Ha): 0.01  
 Search Buffer (m): 1000

Site Details

552670, 175354



Tel: 0844 844 9952  
 Fax: 0844 844 9951  
 Web: www.envirocheck.co.uk



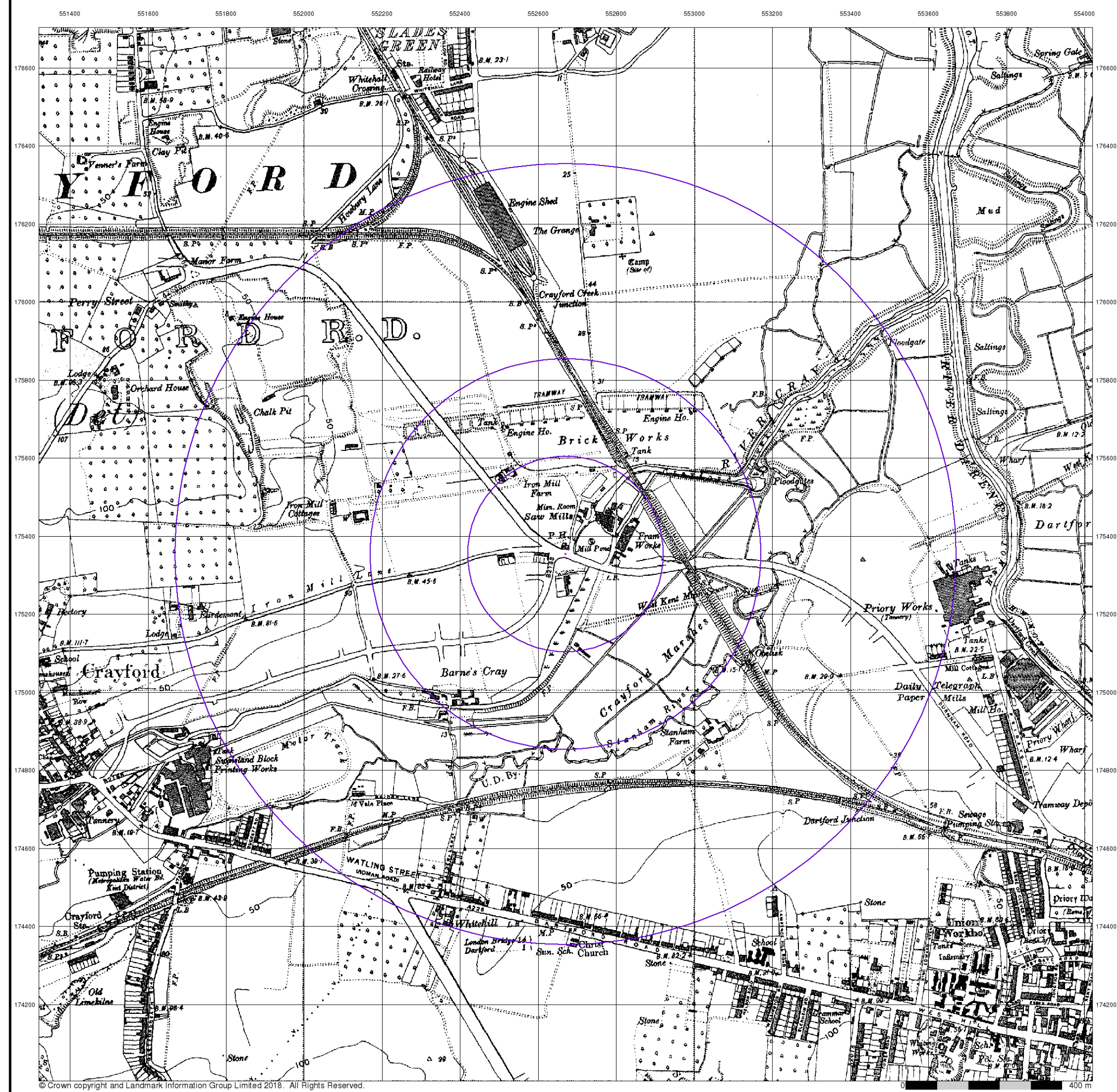

Essex

Published 1938

Source map scale - 1:10,560

The historical maps shown were reproduced from maps predominantly held at the scale adopted for England, Wales and Scotland in the 1840's. In 1854 the 1:2,500 scale was adopted for mapping urban areas; these maps were used to update the 1:10,560 maps. The published date given therefore is often some years later than the surveyed date. Before 1938, all OS maps were based on the Cassini Projection, with independent surveys of a single county or group of counties, giving rise to significant inaccuracies in outlying areas. In the late 1940's, a Provisional Edition was produced, which updated the 1:10,560 mapping from a number of sources. The maps appear unfinished - with all military camps and other strategic sites removed. These maps were initially overprinted with the National Grid. In 1970, the first 1:10,000 maps were produced using the Transverse Mercator Projection. The revision process continued until recently, with new editions appearing every 10 years or so for urban areas.

Map Name(s) and Date(s)

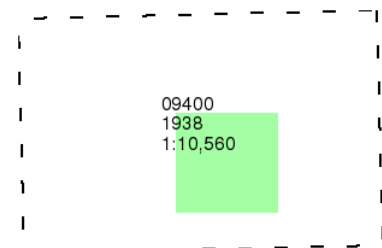

Historical Map - Slice A

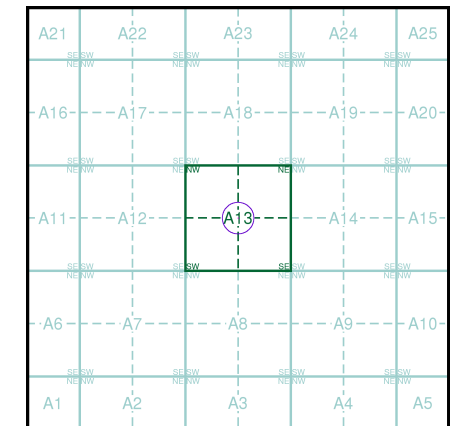

Order Details

Order Number: 159450246\_1\_1  
 Customer Ref: 552670, 175354  
 National Grid Reference: 552670, 175350  
 Slice: A  
 Site Area (Ha): 0.01  
 Search Buffer (m): 1000

Site Details

552670, 175354



Tel: 0844 844 9952  
 Fax: 0844 844 9951  
 Web: www.envirocheck.co.uk



**Kent**

**Published 1939 - 1950**

**Source map scale - 1:10,560**

The historical maps shown were reproduced from maps predominantly held at the scale adopted for England, Wales and Scotland in the 1840's. In 1854 the 1:2,500 scale was adopted for mapping urban areas; these maps were used to update the 1:10,560 maps. The published date given therefore is often some years later than the surveyed date. Before 1938, all OS maps were based on the Cassini Projection, with independent surveys of a single county or group of counties, giving rise to significant inaccuracies in outlying areas. In the late 1940's, a Provisional Edition was produced, which updated the 1:10,560 mapping from a number of sources. The maps appear unfinished - with all military camps and other strategic sites removed. These maps were initially overprinted with the National Grid. In 1970, the first 1:10,000 maps were produced using the Transverse Mercator Projection. The revision process continued until recently, with new editions appearing every 10 years or so for urban areas.

**Map Name(s) and Date(s)**

003SW	1950	1:10,560
009NW	1939	1:10,560

**Historical Map - Slice A**

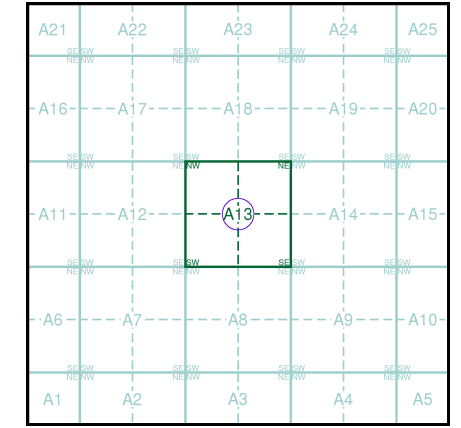

**Order Details**

Order Number: 159450246\_1\_1  
 Customer Ref: 552670, 175354  
 National Grid Reference: 552670, 175350  
 Slice: A  
 Site Area (Ha): 0.01  
 Search Buffer (m): 1000

**Site Details**

552670, 175354



Tel: 0844 844 9952  
 Fax: 0844 844 9951  
 Web: www.envirocheck.co.uk



## Historical Aerial Photography

Published 1947 - 1948

Source map scale - 1:10,560

The Historical Aerial Photos were produced by the Ordnance Survey at a scale of 1:1,250 and 1:10,560 from Air Force photography. They were produced between 1944 and 1951 as an interim measure, pending preparation of conventional mapping, due to post war resource shortages. New security measures in the 1950's meant that every photograph was re-checked for potentially unsafe information with security sites replaced by fake fields or clouds. The original editions were withdrawn and only later made available after a period of fifty years although due to the accuracy of the editing, without viewing both revisions it is not easy to spot the edits. Where available Landmark have included both revisions.

© Landmark Information Group and/or Data Suppliers 2010.

### Map Name(s) and Date(s)

TQ57NW	1948	1:10,560
TQ57SW	1947	1:10,560

### Historical Aerial Photography - Slice A

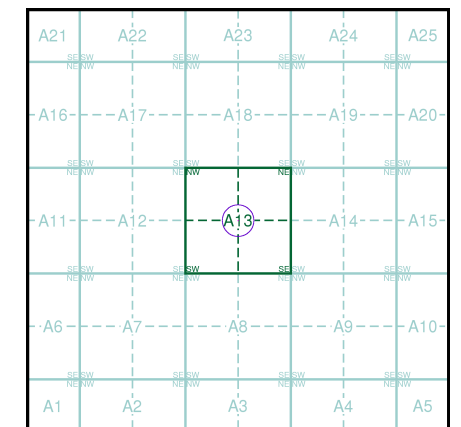

### Order Details

Order Number: 159450246\_1\_1  
 Customer Ref: 552670, 175354  
 National Grid Reference: 552670, 175350  
 Slice: A  
 Site Area (Ha): 0.01  
 Search Buffer (m): 1000

### Site Details

552670, 175354



Tel: 0844 844 9952  
 Fax: 0844 844 9951  
 Web: www.envirocheck.co.uk



### Ordnance Survey Plan

Published 1961

Source map scale - 1:10,000

The historical maps shown were reproduced from maps predominantly held at the scale adopted for England, Wales and Scotland in the 1840's. In 1854 the 1:2,500 scale was adopted for mapping urban areas; these maps were used to update the 1:10,560 maps. The published date given therefore is often some years later than the surveyed date. Before 1938, all OS maps were based on the Cassini Projection, with independent surveys of a single county or group of counties, giving rise to significant inaccuracies in outlying areas. In the late 1940's, a Provisional Edition was produced, which updated the 1:10,560 mapping from a number of sources. The maps appear unfinished - with all military camps and other strategic sites removed. These maps were initially overprinted with the National Grid. In 1970, the first 1:10,000 maps were produced using the Transverse Mercator Projection. The revision process continued until recently, with new editions appearing every 10 years or so for urban areas.

### Map Name(s) and Date(s)

TQ57NW	1961
1:10,560	
TQ57SW	1961
1:10,560	

### Historical Map - Slice A

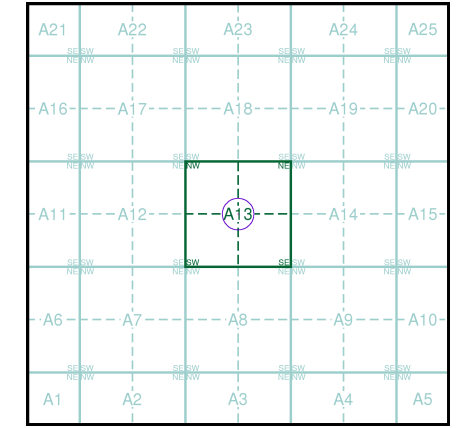

### Order Details

Order Number: 159450246\_1\_1  
 Customer Ref: 552670, 175354  
 National Grid Reference: 552670, 175350  
 Slice: A  
 Site Area (Ha): 0.01  
 Search Buffer (m): 1000

### Site Details

552670, 175354



Tel: 0844 844 9952  
 Fax: 0844 844 9951  
 Web: www.envirocheck.co.uk





**Ordnance Survey Plan**  
**Published 1966 - 1967**  
**Source map scale - 1:10,000**

The historical maps shown were reproduced from maps predominantly held at the scale adopted for England, Wales and Scotland in the 1840's. In 1854 the 1:2,500 scale was adopted for mapping urban areas; these maps were used to update the 1:10,560 maps. The published date given therefore is often some years later than the surveyed date. Before 1938, all OS maps were based on the Cassini Projection, with independent surveys of a single county or group of counties, giving rise to significant inaccuracies in outlying areas. In the late 1940's, a Provisional Edition was produced, which updated the 1:10,560 mapping from a number of sources. The maps appear unfinished - with all military camps and other strategic sites removed. These maps were initially overprinted with the National Grid. In 1970, the first 1:10,000 maps were produced using the Transverse Mercator Projection. The revision process continued until recently, with new editions appearing every 10 years or so for urban areas.

**Map Name(s) and Date(s)**

TQ57NW	1967
1:10,560	
TQ57SW	1966
1:10,560	

**Historical Map - Slice A**

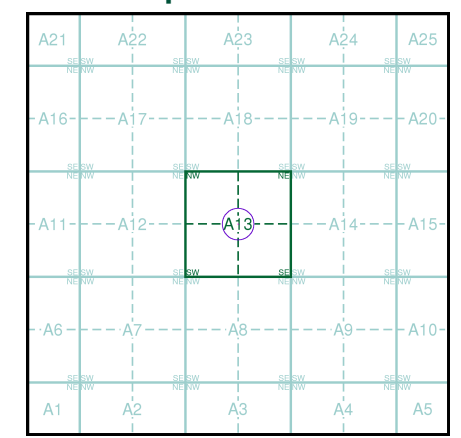

**Order Details**

Order Number: 159450246\_1\_1  
 Customer Ref: 552670, 175354  
 National Grid Reference: 552670, 175350  
 Slice: A  
 Site Area (Ha): 0.01  
 Search Buffer (m): 1000

**Site Details**

552670, 175354



Tel: 0844 844 9952  
 Fax: 0844 844 9951  
 Web: www.envirocheck.co.uk



**Ordnance Survey Plan**

**Published 1975**

**Source map scale - 1:10,000**

The historical maps shown were reproduced from maps predominantly held at the scale adopted for England, Wales and Scotland in the 1840's. In 1854 the 1:2,500 scale was adopted for mapping urban areas; these maps were used to update the 1:10,560 maps. The published date given therefore is often some years later than the surveyed date. Before 1938, all OS maps were based on the Cassini Projection, with independent surveys of a single county or group of counties, giving rise to significant inaccuracies in outlying areas. In the late 1940's, a Provisional Edition was produced, which updated the 1:10,560 mapping from a number of sources. The maps appear unfinished - with all military camps and other strategic sites removed. These maps were initially overprinted with the National Grid. In 1970, the first 1:10,000 maps were produced using the Transverse Mercator Projection. The revision process continued until recently, with new editions appearing every 10 years or so for urban areas.

**Map Name(s) and Date(s)**

TQ57NW	1975	1:10,000
TQ57SW	1975	1:10,000

**Historical Map - Slice A**

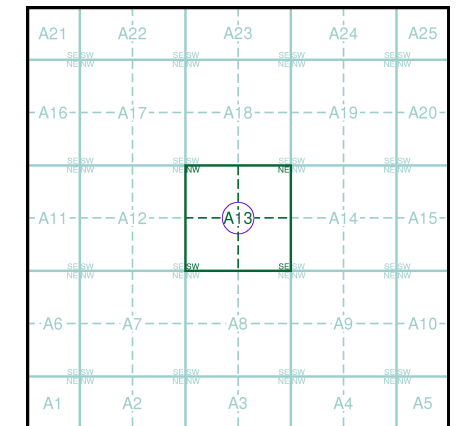

**Order Details**

Order Number: 159450246\_1\_1  
 Customer Ref: 552670, 175354  
 National Grid Reference: 552670, 175350  
 Slice: A  
 Site Area (Ha): 0.01  
 Search Buffer (m): 1000

**Site Details**

552670, 175354



Tel: 0844 844 9952  
 Fax: 0844 844 9951  
 Web: www.envirocheck.co.uk

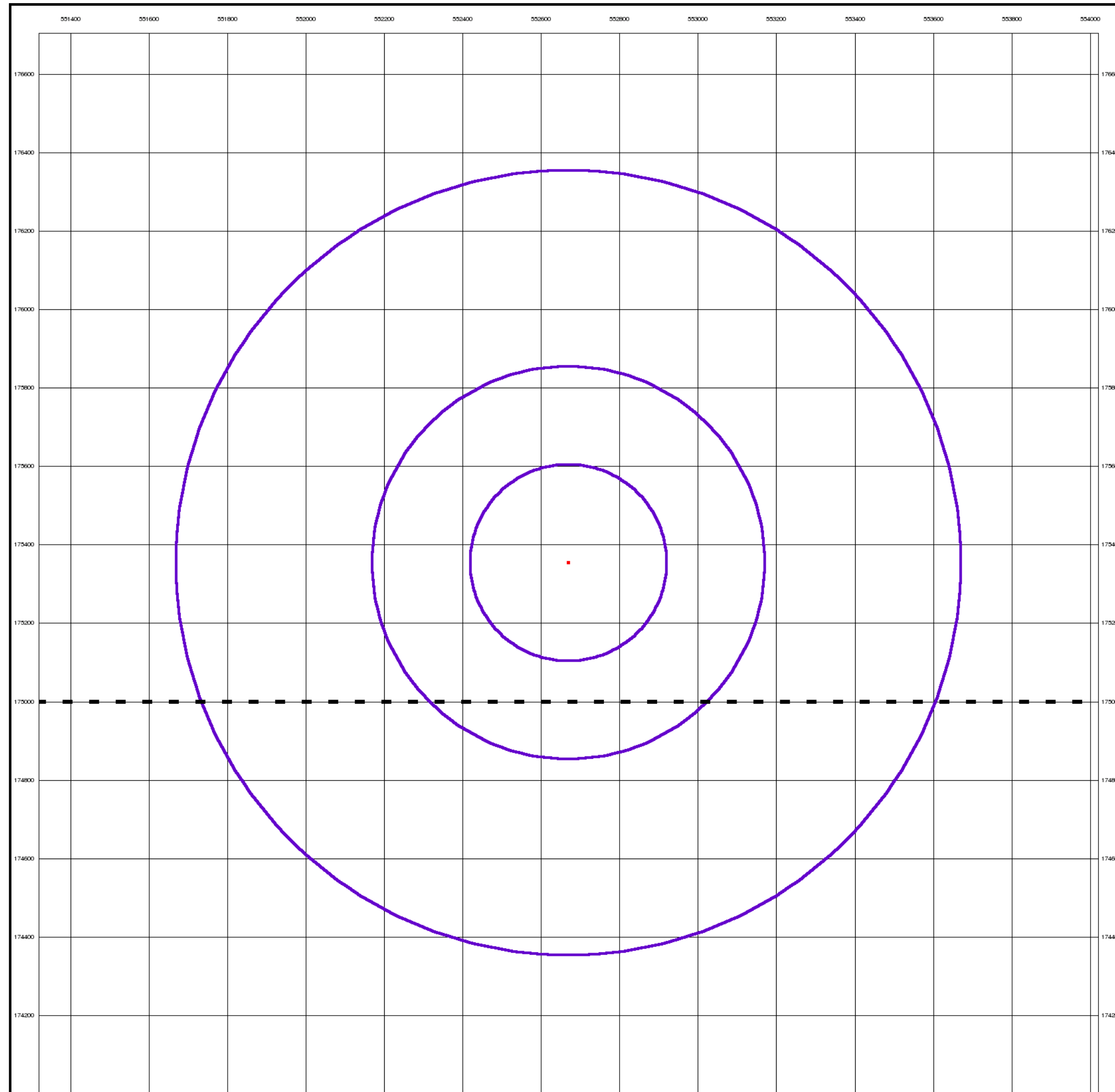

**Gravesend**

**Published 1977**

**Source map scale - 1:10,000**

These maps were produced by the Russian military during the Cold War between 1950 and 1997, and cover 103 towns and cities throughout the U.K. The maps are produced at 1:25,000, 1:10,000 and 1:5,000 scale, and show detailed land use, with colour-coded areas for development, green areas, and non-developed areas. Buildings are coloured black and important building uses (such as hospitals, post offices, factories etc.) are numbered, with a numbered key describing their use.

They were produced by the Russians for the benefit of navigation, as well as strategic military sites and transport hubs, for use if they were to have invaded the U.K. The detailed information provided indicates that the areas were surveyed using land-based personnel, on the ground, in the cities that are mapped.

**Map Name(s) and Date(s)**

TQ57NW  
1977  
1:10,000

TQ57SW  
1977  
1:10,000

**Russian Map - Slice A**

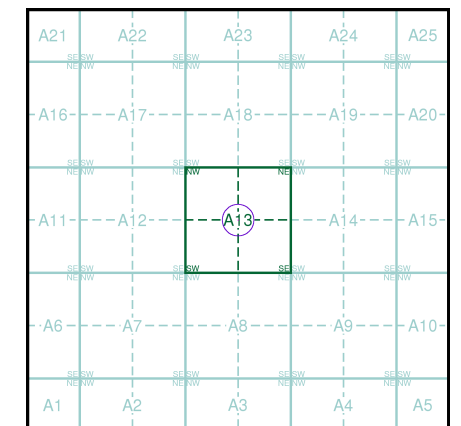

**Order Details**

Order Number: 159450246\_1\_1  
 Customer Ref: 552670, 175354  
 National Grid Reference: 552670, 175350  
 Slice: A  
 Site Area (Ha): 0.01  
 Search Buffer (m): 1000

**Site Details**

552670, 175354



Tel: 0844 844 9952  
 Fax: 0844 844 9951  
 Web: www.envirocheck.co.uk

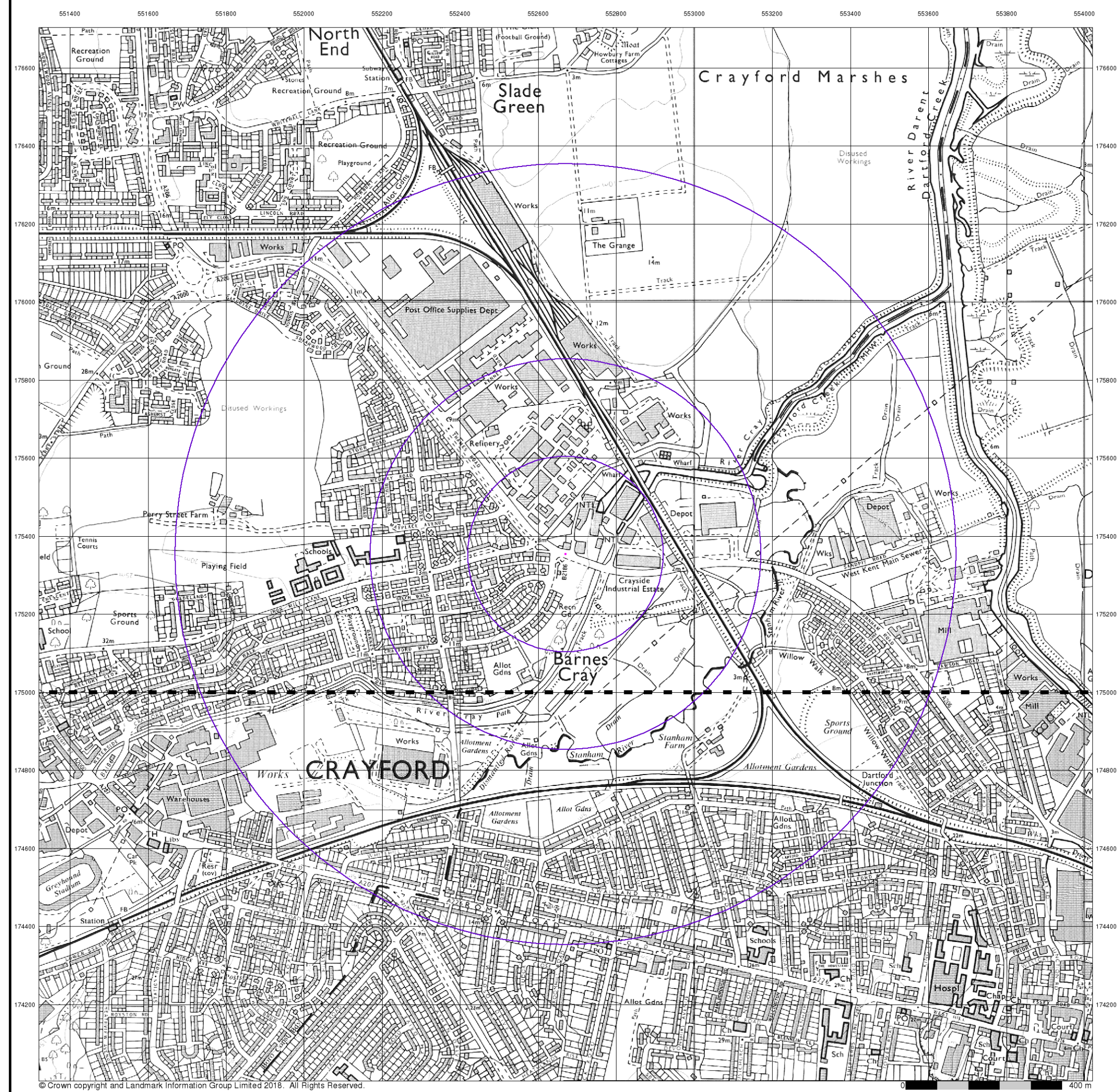

**Ordnance Survey Plan**  
**Published 1983 - 1987**  
**Source map scale - 1:10,000**

The historical maps shown were reproduced from maps predominantly held at the scale adopted for England, Wales and Scotland in the 1840's. In 1854 the 1:2,500 scale was adopted for mapping urban areas; these maps were used to update the 1:10,560 maps. The published date given therefore is often some years later than the surveyed date. Before 1938, all OS maps were based on the Cassini Projection, with independent surveys of a single county or group of counties, giving rise to significant inaccuracies in outlying areas. In the late 1940's, a Provisional Edition was produced, which updated the 1:10,560 mapping from a number of sources. The maps appear unfinished - with all military camps and other strategic sites removed. These maps were initially overprinted with the National Grid. In 1970, the first 1:10,000 maps were produced using the Transverse Mercator Projection. The revision process continued until recently, with new editions appearing every 10 years or so for urban areas.

**Map Name(s) and Date(s)**

TQ57NW	1987	1:10,000
TQ57SW	1983	1:10,000

**Historical Map - Slice A**

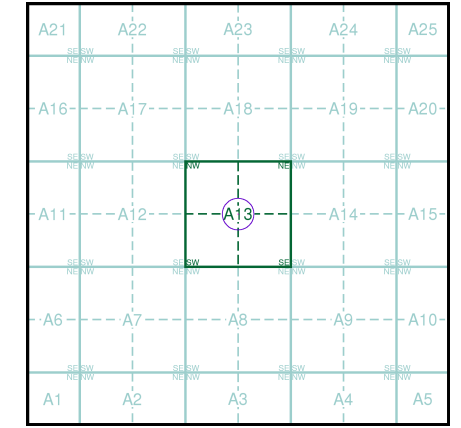

**Order Details**

Order Number: 159450246\_1\_1  
 Customer Ref: 552670, 175354  
 National Grid Reference: 552670, 175350  
 Slice: A  
 Site Area (Ha): 0.01  
 Search Buffer (m): 1000

**Site Details**

552670, 175354



Tel: 0844 844 9952  
 Fax: 0844 844 9951  
 Web: www.envirocheck.co.uk



London

Published 1985

Source map scale - 1:25,000

These maps were produced by the Russian military during the Cold War between 1950 and 1997, and cover 103 towns and cities throughout the U.K. The maps are produced at 1:25,000, 1:10,000 and 1:5,000 scale, and show detailed land use, with colour-coded areas for development, green areas, and non-developed areas. Buildings are coloured black and important building uses (such as hospitals, post offices, factories etc.) are numbered, with a numbered key describing their use.

They were produced by the Russians for the benefit of navigation, as well as strategic military sites and transport hubs, for use if they were to have invaded the U.K. The detailed information provided indicates that the areas were surveyed using land-based personnel, on the ground, in the cities that are mapped.

Map Name(s) and Date(s)

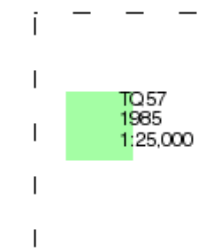

Russian Map - Slice A

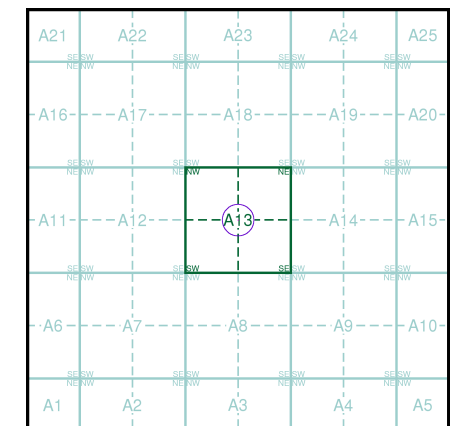

Order Details

Order Number: 159450246\_1\_1  
 Customer Ref: 552670, 175354  
 National Grid Reference: 552670, 175350  
 Slice: A  
 Site Area (Ha): 0.01  
 Search Buffer (m): 1000

Site Details

552670, 175354



Tel: 0844 844 9952  
 Fax: 0844 844 9951  
 Web: www.envirocheck.co.uk

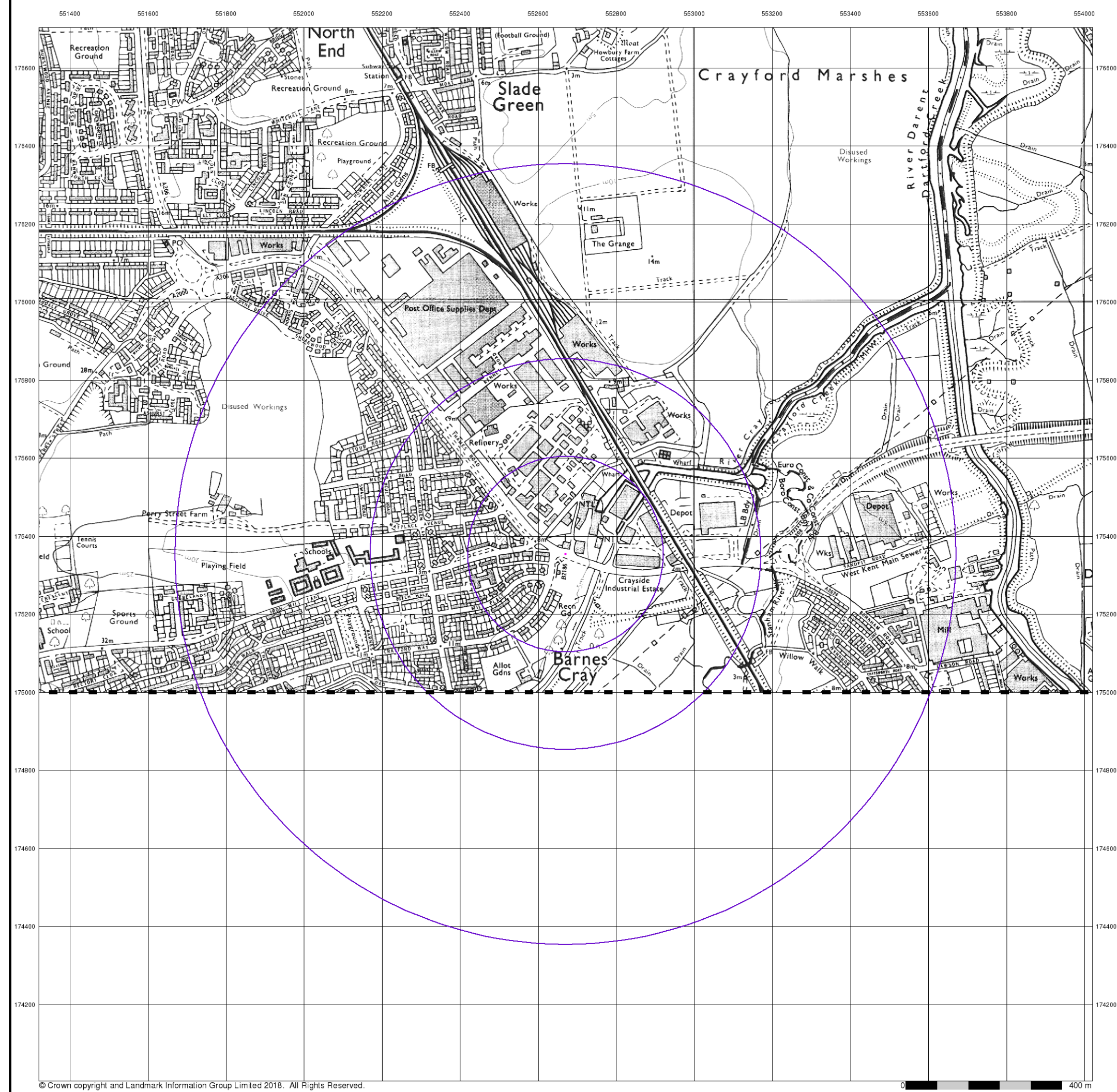

**Ordnance Survey Plan**

**Published 1996**

**Source map scale - 1:10,000**

The historical maps shown were reproduced from maps predominantly held at the scale adopted for England, Wales and Scotland in the 1840's. In 1854 the 1:2,500 scale was adopted for mapping urban areas; these maps were used to update the 1:10,560 maps. The published date given therefore is often some years later than the surveyed date. Before 1938, all OS maps were based on the Cassini Projection, with independent surveys of a single county or group of counties, giving rise to significant inaccuracies in outlying areas. In the late 1940's, a Provisional Edition was produced, which updated the 1:10,560 mapping from a number of sources. The maps appear unfinished - with all military camps and other strategic sites removed. These maps were initially overprinted with the National Grid. In 1970, the first 1:10,000 maps were produced using the Transverse Mercator Projection. The revision process continued until recently, with new editions appearing every 10 years or so for urban areas.

**Map Name(s) and Date(s)**

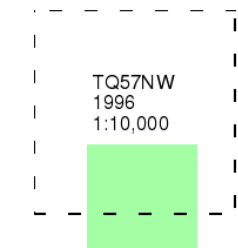

**Historical Map - Slice A**

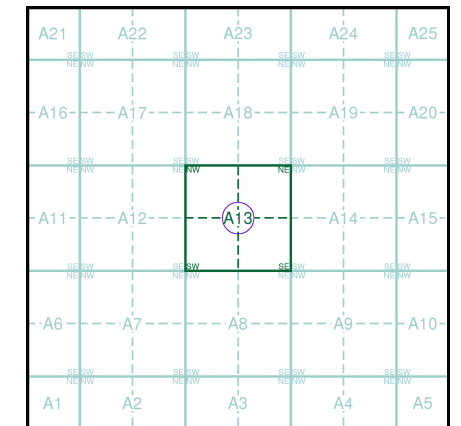

**Order Details**

Order Number: 159450246\_1\_1  
 Customer Ref: 552670, 175354  
 National Grid Reference: 552670, 175350  
 Slice: A  
 Site Area (Ha): 0.01  
 Search Buffer (m): 1000

**Site Details**

552670, 175354



Tel: 0844 844 9952  
 Fax: 0844 844 9951  
 Web: www.envirocheck.co.uk



### 10k Raster Mapping

Published 1999

Source map scale - 1:10,000

The historical maps shown were produced from the Ordnance Survey's 1:10,000 colour raster mapping. These maps are derived from Landplan which replaced the old 1:10,000 maps originally published in 1970. The data is highly detailed showing buildings, fences and field boundaries as well as all roads, tracks and paths. Road names are also included together with the relevant road number and classification. Boundary information depiction includes county, unitary authority, district, civil parish and constituency.

### Map Name(s) and Date(s)

TQ57NW	1999	1:10,000
TQ57SW	1999	1:10,000

### Historical Map - Slice A

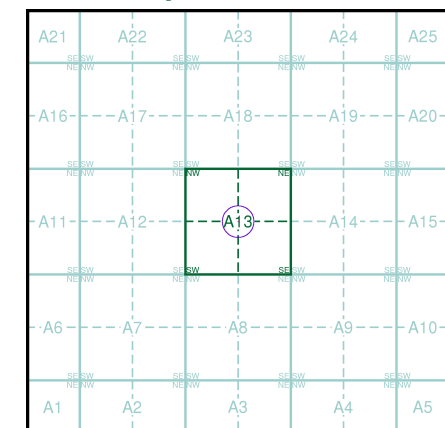

### Order Details

Order Number: 159450246\_1\_1  
 Customer Ref: 552670, 175354  
 National Grid Reference: 552670, 175350  
 Slice: A  
 Site Area (Ha): 0.01  
 Search Buffer (m): 1000

### Site Details

552670, 175354



Tel: 0844 844 9952  
 Fax: 0844 844 9951  
 Web: www.envirocheck.co.uk

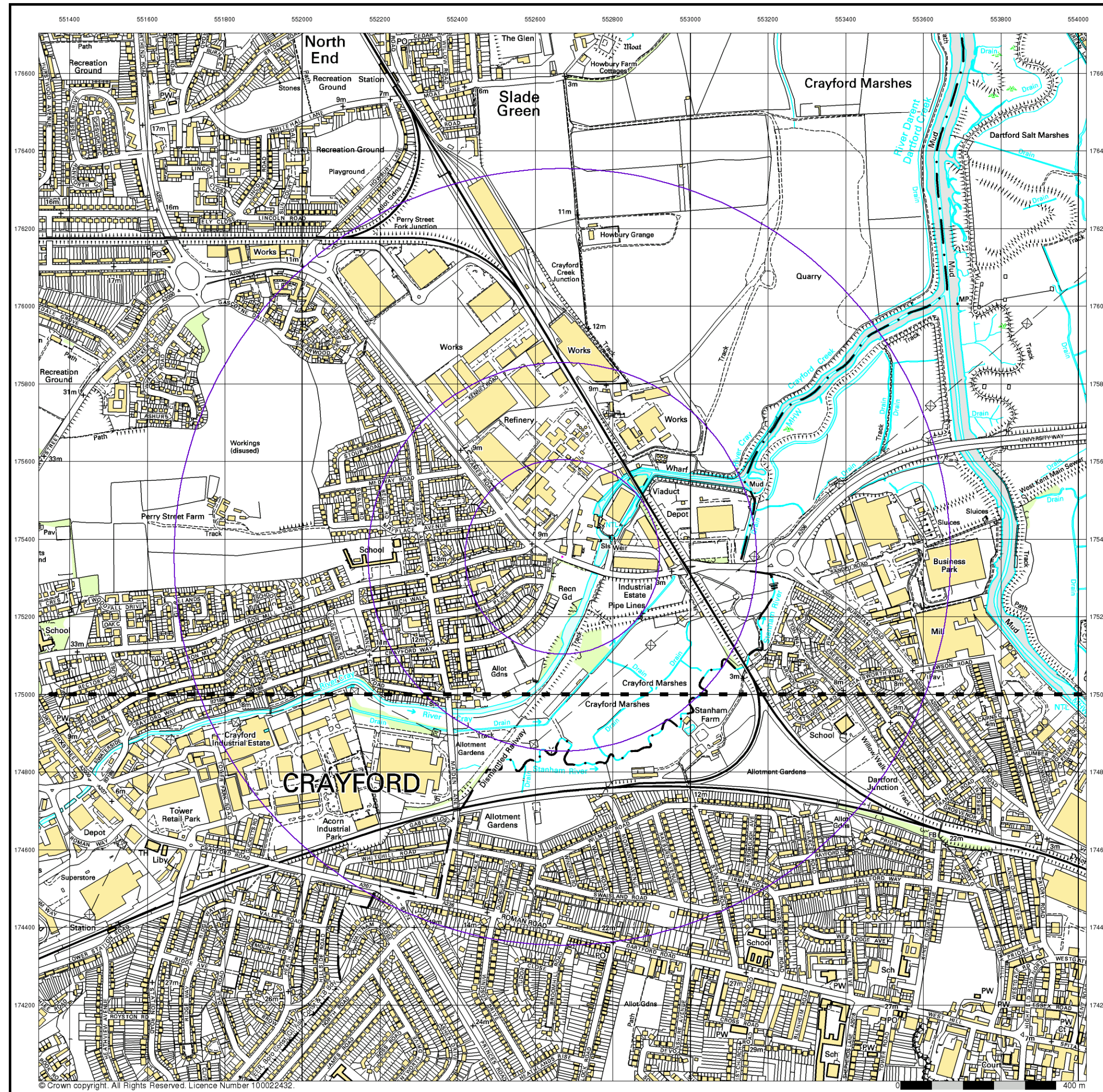

## 10k Raster Mapping

Published 2006

Source map scale - 1:10,000

The historical maps shown were produced from the Ordnance Survey's 1:10,000 colour raster mapping. These maps are derived from Landplan which replaced the old 1:10,000 maps originally published in 1970. The data is highly detailed showing buildings, fences and field boundaries as well as all roads, tracks and paths. Road names are also included together with the relevant road number and classification. Boundary information depiction includes county, unitary authority, district, civil parish and constituency.

### Map Name(s) and Date(s)

TQ57NW |  
2006 |  
1:10,000 |  
TQ57SW |  
2006 |  
1:10,000 |

### Historical Map - Slice A

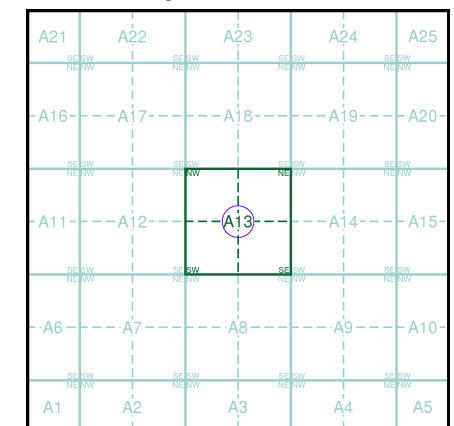

### Order Details

Order Number: 159450246\_1\_1  
Customer Ref: 552670, 175354  
National Grid Reference: 552670, 175350  
Slice: A  
Site Area (Ha): 0.01  
Search Buffer (m): 1000

### Site Details

552670, 175354



Tel: 0844 844 9952  
Fax: 0844 844 9951  
Web: www.envirocheck.co.uk





© Crown copyright. All Rights Reserved. Licence Number 100022432.



**VectorMap Local**

Published 2018

Source map scale - 1:10,000

VectorMap Local (Raster) is Ordnance Survey's highest detailed 'backdrop' mapping product. These maps are produced from OS's VectorMap Local, a simple vector dataset at a nominal scale of 1:10,000, covering the whole of Great Britain, that has been designed for creating graphical mapping. OS VectorMap Local is derived from large-scale information surveyed at 1:1250 scale (covering major towns and cities), 1:2500 scale (smaller towns, villages and developed rural areas), and 1:10 000 scale (mountain, moorland and river estuary areas).

**Map Name(s) and Date(s)**

- TQ57NW | 2018 | Variable
- TQ57SW | 2018 | Variable

**Historical Map - Slice A**

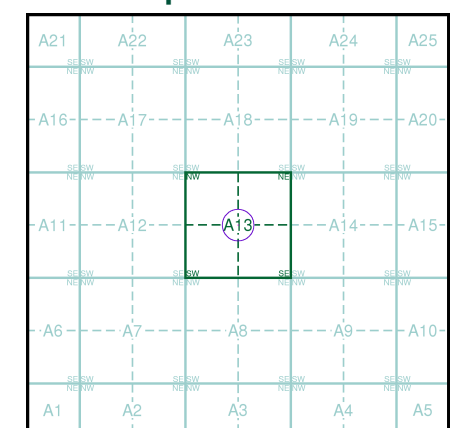

**Order Details**

Order Number: 159450246\_1\_1  
 Customer Ref: 552670, 175354  
 National Grid Reference: 552670, 175350  
 Slice: A  
 Site Area (Ha): 0.01  
 Search Buffer (m): 1000

**Site Details**

552670, 175354



Tel: 0844 844 9952  
 Fax: 0844 844 9951  
 Web: www.envirocheck.co.uk

# Historical Mapping Legends

## Ordnance Survey County Series 1:10,560

- Gravel Pit
- Sand Pit
- Other Pits
- Quarry
- Shingle
- Orchard
- Osiers
- Reeds
- Marsh
- Mixed Wood
- Deciduous
- Brushwood
- Fir
- Furze
- Rough Pasture
- Arrow denotes flow of water
- Trigonometrical Station
- Site of Antiquities
- Bench Mark
- Pump, Guide Post, Signal Post
- Well, Spring, Boundary Post
- 285** Surface Level
- Sketched Contour
- Instrumental Contour
- Main Roads
- Minor Roads
- Sunken Road
- Raised Road
- Road over Railway
- Railway over River
- Railway over Road
- Level Crossing
- Road over River or Canal
- Road over Stream
- Road over Stream
- County Boundary (Geographical)
- County & Civil Parish Boundary
- Administrative County & Civil Parish Boundary
- County Borough Boundary (England)
- County Burgh Boundary (Scotland)
- Rural District Boundary
- Civil Parish Boundary

## Ordnance Survey Plan 1:10,000

- Chalk Pit, Clay Pit or Quarry
- Gravel Pit
- Sand Pit
- Disused Pit or Quarry
- Refuse or Slag Heap
- Lake, Loch or Pond
- Dunes
- Boulders
- Coniferous Trees
- Non-Coniferous Trees
- Orchard
- Scrub
- Coppice
- Bracken
- Heath
- Rough Grassland
- Marsh
- Reeds
- Saltings
- Building
- Glasshouse
- Sloping Masonry
- Pylon
- Electricity Transmission Line
- Pole
- Cutting
- Embankment
- Standard Gauge Multiple Track
- Standard Gauge Single Track
- Siding, Tramway or Mineral Line
- Narrow Gauge
- Geographical County
- Administrative County, County Borough or County of City
- Municipal Borough, Urban or Rural District, Burgh or District Council
- Borough, Burgh or County Constituency  
Shown only when not coincident with other boundaries
- Civil Parish  
Shown alternately when coincidence of boundaries occurs
- BP, BS Boundary Post or Stone
- Ch Church
- CH Club House
- F E Sta Fire Engine Station
- FB Foot Bridge
- Fn Fountain
- GP Guide Post
- MP Mile Post
- MS Mile Stone
- Pol Sta Police Station
- PO Post Office
- PC Public Convenience
- PH Public House
- SB Signal Box
- Spr Spring
- TCB Telephone Call Box
- TCP Telephone Call Post
- W Well

## 1:10,000 Raster Mapping

- Gravel Pit
- Rock
- Boulders
- Shingle
- Sand
- Slopes
- General detail
- Overhead detail
- Multi-track railway
- County boundary (England only)
- District, Unitary, Metropolitan, London Borough boundary
- Area of wooded vegetation
- Non-coniferous trees (scattered)
- Coniferous trees (scattered)
- Orchard
- Rough Grassland
- Scrub
- Water feature
- MHW(S) Mean high water (springs)
- Telephone line (where shown)
- Bench mark (where shown)
- Point feature (e.g. Guide Post or Mile Stone)
- Site of (antiquity)
- General Building
- Refuse tip or slag heap
- Rock (scattered)
- Boulders (scattered)
- Mud
- Sand Pit
- Top of cliff
- Underground detail
- Narrow gauge railway
- Single track railway
- Civil, parish or community boundary
- Constituency boundary
- Non-coniferous trees
- Coniferous trees
- Positioned tree
- Coppice or Osiers
- Heath
- Marsh, Salt Marsh or Reeds
- Flow arrows
- MLW(S) Mean low water (springs)
- Electricity transmission line (with poles)
- Triangulation station
- Pylon, flare stack or lighting tower
- Glasshouse
- Important Building



## Historical Mapping & Photography included:

Mapping Type	Scale	Date	Pg
Kent	1:10,560	1869	3
Essex	1:10,560	1873	4
Essex	1:10,560	1898 - 1899	5
Kent	1:10,560	1898	6
Kent	1:10,560	1910	7
London	1:10,560	1920	8
Essex	1:10,560	1921	9
Kent	1:10,560	1931	10
Kent	1:10,560	1938	11
Essex	1:10,560	1938	12
London	1:10,560	1938	13
Essex	1:10,560	1938	14
Historical Aerial Photography	1:10,560	1947 - 1949	15
Historical Aerial Photography	1:10,560	1947	16
Kent	1:10,560	1950 - 1951	17
Ordnance Survey Plan	1:10,000	1961	18
Ordnance Survey Plan	1:10,000	1966 - 1967	19
Ordnance Survey Plan	1:10,000	1975 - 1977	20
Gravesend	1:10,000	1977	21
London	1:25,000	1985	22
Ordnance Survey Plan	1:10,000	1987 - 1989	23
Ordnance Survey Plan	1:10,000	1993 - 1996	24
Ordnance Survey Plan	1:10,000	1996	25
10K Raster Mapping	1:10,000	1999	26
10K Raster Mapping	1:10,000	2006	27
VectorMap Local	1:10,000	2018	28

## Historical Map - Slice A

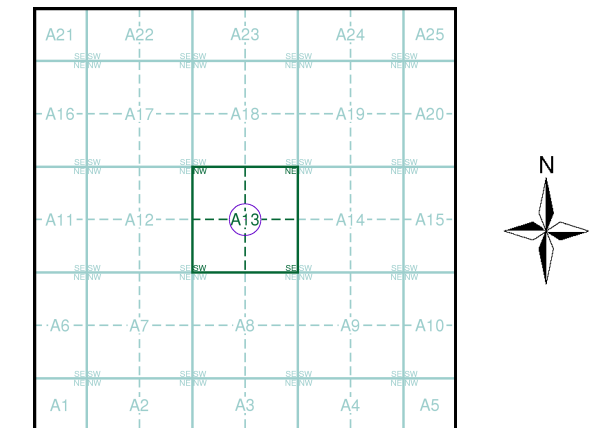

## Order Details

Order Number: 159449760\_1\_1  
 Customer Ref: 555065, 179077  
 National Grid Reference: 555060, 179080  
 Slice: A  
 Site Area (Ha): 0.01  
 Search Buffer (m): 1000

## Site Details

555065, 179077



Tel: 0844 844 9952  
 Fax: 0844 844 9951  
 Web: www.envirocheck.co.uk

# Russian Military Mapping Legends

## 1:5,000 and 1:10,000 mapping

a. Not drawn to scale b. Drawn to scale

	Government and Administrative Buildings		Military and Industrial Buildings
	Military and Communication Areas		Subway Entrance
	Fireproof Building		Prominent Fireproof Building
	Non-fireproof Building		Non-fireproof Building (non-dwelling)
	Factory, mill, and flour mill, with chimneys		Factory, mill, and flour mill, without chimneys
	Power Station, drawn to scale		Hydroelectric Power Station
	Radio Station, drawn to scale		Telephone Station, drawn to scale
	Abandoned Open-pit Mine or Quarry		Open-pit Salt Mine
	Pit		Oil Deposit or Well
	Oil Seepage		Natural Gas Tank
	Tailings Pile		Fuel Storage Tanks
	Bench Mark		Drill Hole
	Burial Mound		Triangulation Point on Burial Mound
	Single-track Railroad		Double-track Railroad
	Small Bridge		Tunnel
	Pipe (Culvert)		Railroad and Station Building
	Coniferous Forest		Deciduous Forest
	Mixed Forest		Lawns
	Citrus Orchard		Wet Ground
	Scattered Vegetation		

**243,8** Values for prominent elevations  
**186.0** Numbers for spot elevations, depth soundings, contour lines, etc.  
**0,2** Velocity of the current, width of river bed, depth of river  
**180/12** Fractional terms: length and capacity of bridges; depth of fords and condition of the river bottom; height of forest and the diameter of trees

### Russian Alphabet (For reference and phonetic interpretation of map text)

<b>А а (A)</b>	<b>З з (Z)</b>	<b>П п (P)</b>	<b>Ч ч (CH)</b>
<b>Б б (B)</b>	<b>И и (I)</b>	<b>Р р (R)</b>	<b>Ш ш (SH)</b>
<b>В в (V)</b>	<b>Й й (Y)</b>	<b>С с (S)</b>	<b>Щ щ (SHCH)</b>
<b>Г г (G)</b>	<b>К к (K)</b>	<b>Т т (T)</b>	<b>Ъ (-)</b>
<b>Д д (D)</b>	<b>Л л (L)</b>	<b>У у (U)</b>	<b>Ы (Y)</b>
<b>Е е (E)</b>	<b>М м (M)</b>	<b>Ф ф (F)</b>	<b>Ь (')</b>
<b>Ё ё (YO)</b>	<b>Н н (N)</b>	<b>Х х (KH)</b>	<b>Э э (E)</b>
<b>Ж ж (ZH)</b>	<b>О о (O)</b>	<b>Ц ц (TS)</b>	<b>Ю ю (YU or IU)</b>
			<b>Я я (YA or IA)</b>

## 1:25,000 mapping

a. Not drawn to scale b. Drawn to scale

	Government and Administrative Buildings		Military and Industrial Buildings
	Military and Communication Areas		Subway Entrance
	Partly Demolished Buildings		Demolished Buildings
	Built-Up Area with Fireproof Buildings Predominant		Built-Up Area with Non-Fireproof Buildings Predominant
	Individual Fireproof Building		Prominent Industrial Building
	Individual Dwelling, Fireproof		Ruins of an Individual Dwelling
	Factory or Mill Chimney		Factory or Mill with Chimney
	Factory or Mill without Chimney		Mine or Open Pit Mine
	Operating Shaft or Mine		Non-Operating Shaft or Mine
	Salt Mine		Tailings Pile
	Pit		Stone Quarry
	Gas Pump or Service Station		Fuel Storage or Natural Gas Tank
	Oil or Natural Gas Derrick		Small Hydroelectric Power Station
	Power Station		Transformer Station
	Cemetery		Burial Mound (height in metres)
	Triangulation Point on Burial Mound		Triangulation Point
	Bench Mark		Bench Mark (monumented)
	Telegraph Office		Telephone Station
	Radio Station		Radio Tower
	Airfield or Seaplane Base		Landing Strip
	Cut		Fill
	Km Post		Plantings
	Telegraph/Telephone Lines		Main Highway
	Highway under Construction		Improved Dirt Road (former truck road)
	Steep Grade		Width of Road
	Small Bridge		Pipe (Culvert)
	Tunnel		Dismantled Railroad
	Double-track Railroad with First Class Station		Railroad Under Construction
	Shore Embankment		River or Ditch with Embankment
	Water Reservoir or Rain Water Pit		Spring
	Well		Isobath with value
	Heavy (Index) Contour Line		Half Contour Line
	Contour Line and Value		Spot Elevation Value
	Coniferous		Deciduous
	Mixed		Scrub

## Key to Numbers on Mapping

### TQ57NE\_Gravesend

No.	Description
22	Storage (Flammable And Lubricant Materials)

### TQ57\_London

No.	Description
231	Military Barracks
266	Warehouse (Use Unknown)
276	Storage (Flammable And Lubricant Materials)



## Historical Mapping & Photography included:

Mapping Type	Scale	Date	Pg
Kent	1:10,560	1869	3
Essex	1:10,560	1873	4
Essex	1:10,560	1898 - 1899	5
Kent	1:10,560	1898	6
Kent	1:10,560	1910	7
London	1:10,560	1920	8
Essex	1:10,560	1921	9
Kent	1:10,560	1931	10
Kent	1:10,560	1938	11
Essex	1:10,560	1938	12
London	1:10,560	1938	13
Essex	1:10,560	1938	14
Historical Aerial Photography	1:10,560	1947 - 1949	15
Historical Aerial Photography	1:10,560	1947	16
Kent	1:10,560	1950 - 1951	17
Ordnance Survey Plan	1:10,000	1961	18
Ordnance Survey Plan	1:10,000	1966 - 1967	19
Ordnance Survey Plan	1:10,000	1975 - 1977	20
Gravesend	1:10,000	1977	21
London	1:25,000	1985	22
Ordnance Survey Plan	1:10,000	1987 - 1989	23
Ordnance Survey Plan	1:10,000	1993 - 1996	24
Ordnance Survey Plan	1:10,000	1996	25
10K Raster Mapping	1:10,000	1999	26
10K Raster Mapping	1:10,000	2006	27
VectorMap Local	1:10,000	2018	28

## Russian Map - Slice A

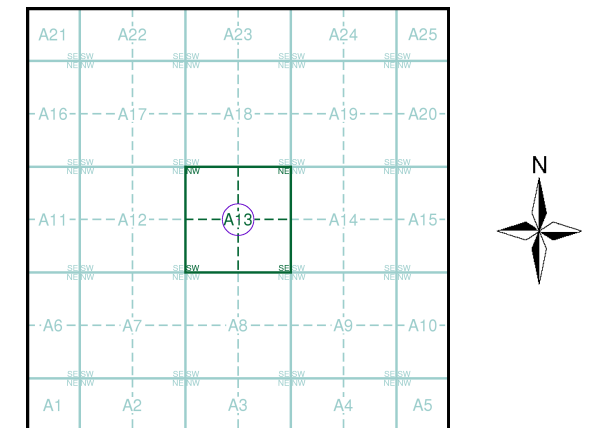

## Order Details

Order Number: 159449760\_1\_1  
 Customer Ref: 555065, 179077  
 National Grid Reference: 555060, 179080  
 Slice: A  
 Site Area (Ha): 0.01  
 Search Buffer (m): 1000

## Site Details

555065, 179077



Tel: 0844 844 9952  
 Fax: 0844 844 9951  
 Web: www.envirocheck.co.uk

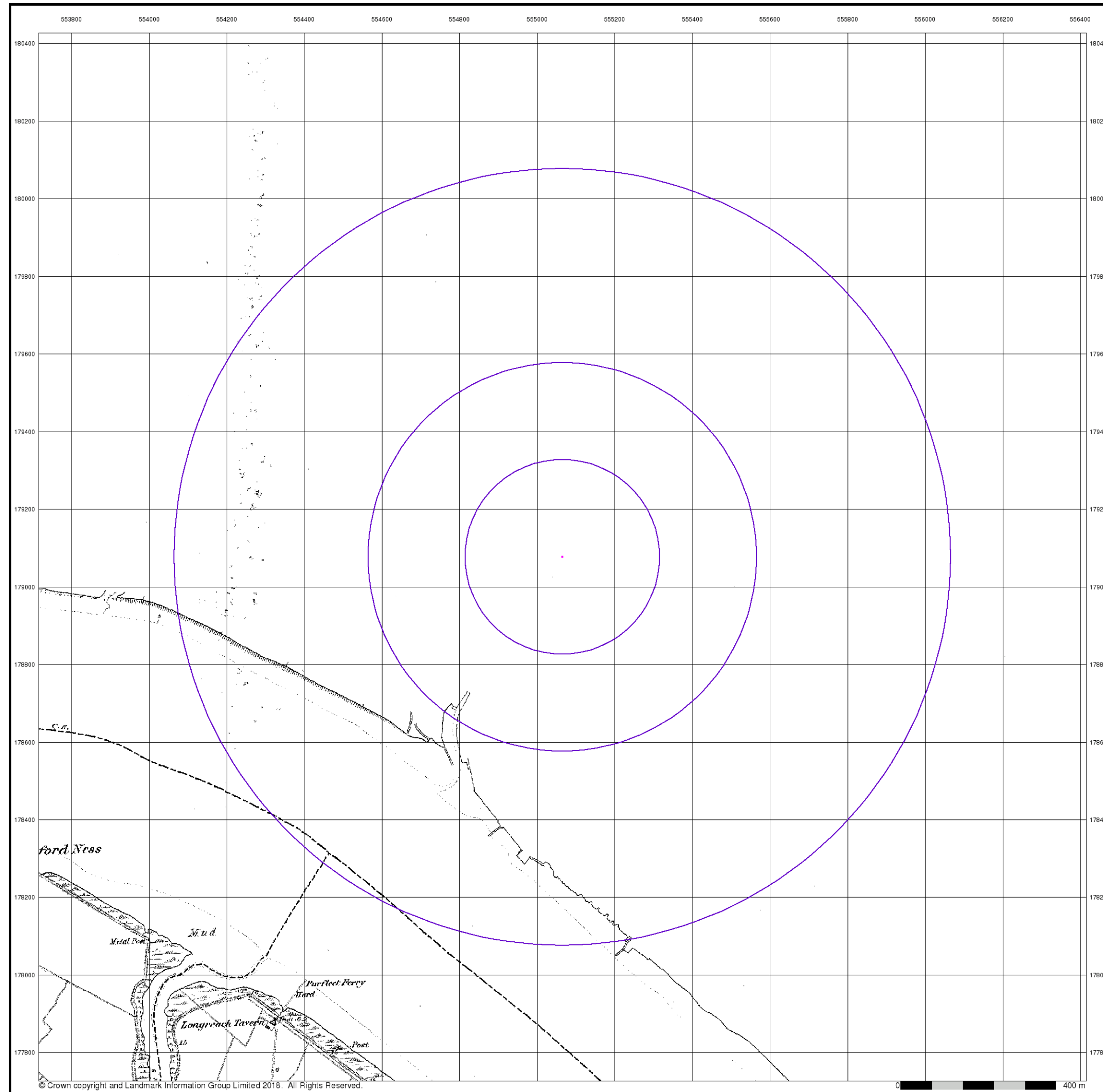

**Kent**

**Published 1869**

**Source map scale - 1:10,560**

The historical maps shown were reproduced from maps predominantly held at the scale adopted for England, Wales and Scotland in the 1840's. In 1854 the 1:2,500 scale was adopted for mapping urban areas; these maps were used to update the 1:10,560 maps. The published date given therefore is often some years later than the surveyed date. Before 1938, all OS maps were based on the Cassini Projection, with independent surveys of a single county or group of counties, giving rise to significant inaccuracies in outlying areas. In the late 1940's, a Provisional Edition was produced, which updated the 1:10,560 mapping from a number of sources. The maps appear unfinished - with all military camps and other strategic sites removed. These maps were initially overprinted with the National Grid. In 1970, the first 1:10,000 maps were produced using the Transverse Mercator Projection. The revision process continued until recently, with new editions appearing every 10 years or so for urban areas.

**Map Name(s) and Date(s)**

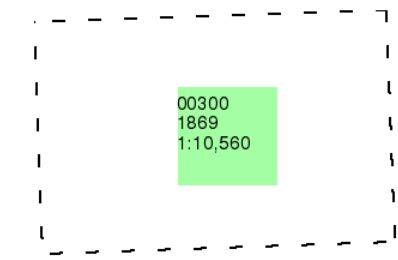

**Historical Map - Slice A**

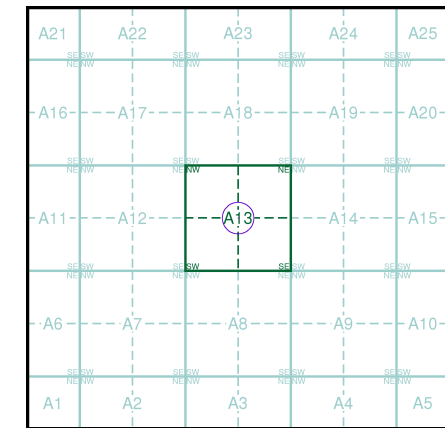

**Order Details**

Order Number: 159449760\_1\_1  
 Customer Ref: 555065, 179077  
 National Grid Reference: 555060, 179080  
 Slice: A  
 Site Area (Ha): 0.01  
 Search Buffer (m): 1000

**Site Details**

555065, 179077



Tel: 0844 844 9952  
 Fax: 0844 844 9951  
 Web: www.envirocheck.co.uk

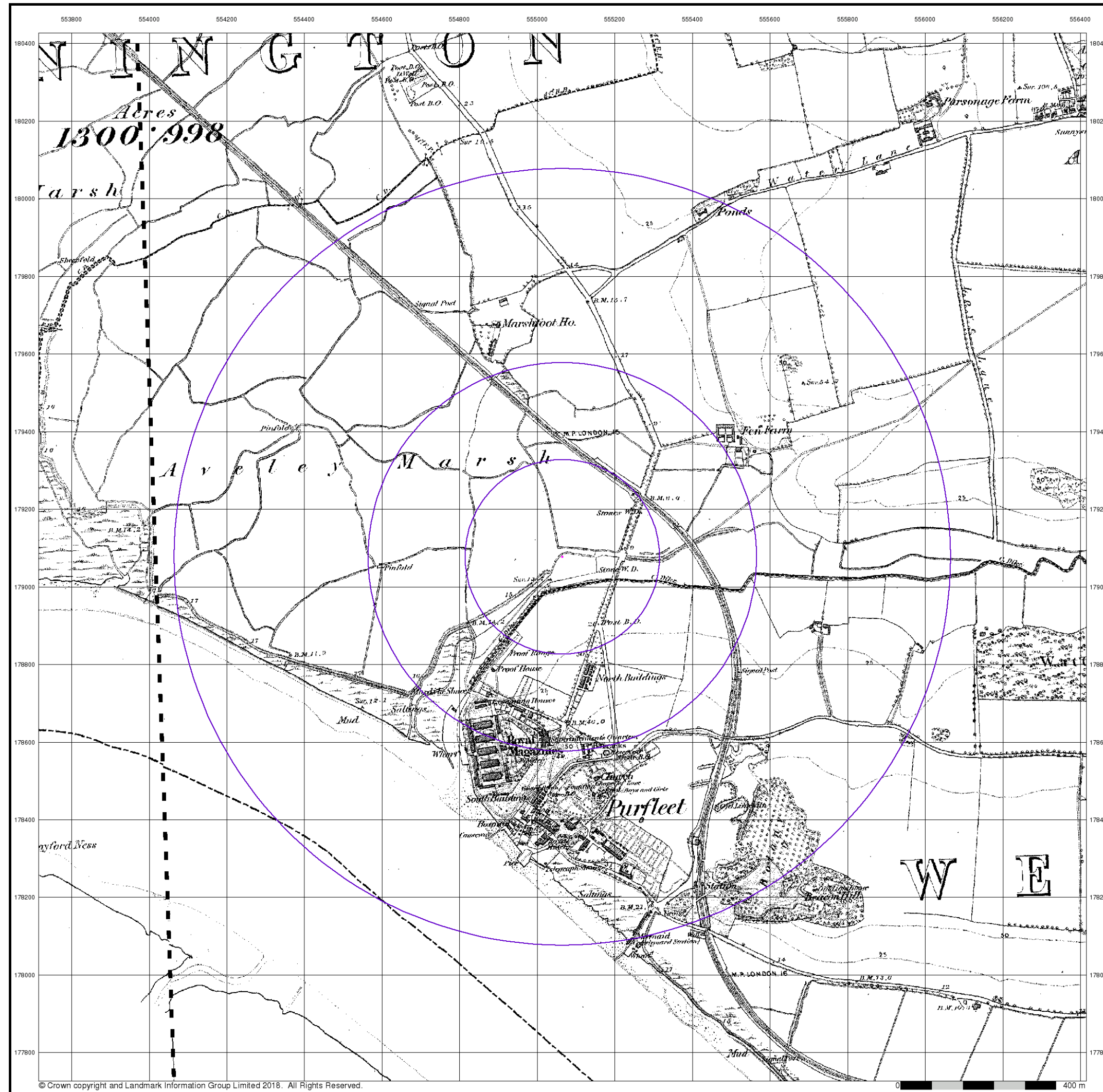

Essex

Published 1873

Source map scale - 1:10,560

The historical maps shown were reproduced from maps predominantly held at the scale adopted for England, Wales and Scotland in the 1840's. In 1854 the 1:2,500 scale was adopted for mapping urban areas; these maps were used to update the 1:10,560 maps. The published date given therefore is often some years later than the surveyed date. Before 1938, all OS maps were based on the Cassini Projection, with independent surveys of a single county or group of counties, giving rise to significant inaccuracies in outlying areas. In the late 1940's, a Provisional Edition was produced, which updated the 1:10,560 mapping from a number of sources. The maps appear unfinished - with all military camps and other strategic sites removed. These maps were initially overprinted with the National Grid. In 1970, the first 1:10,000 maps were produced using the Transverse Mercator Projection. The revision process continued until recently, with new editions appearing every 10 years or so for urban areas.

Map Name(s) and Date(s)

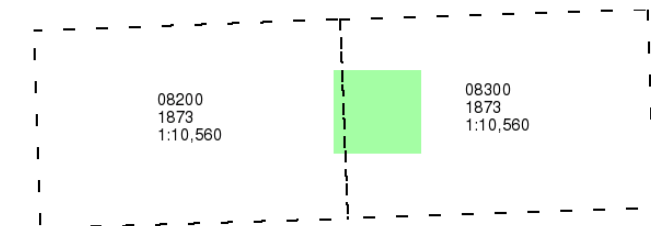

Historical Map - Slice A

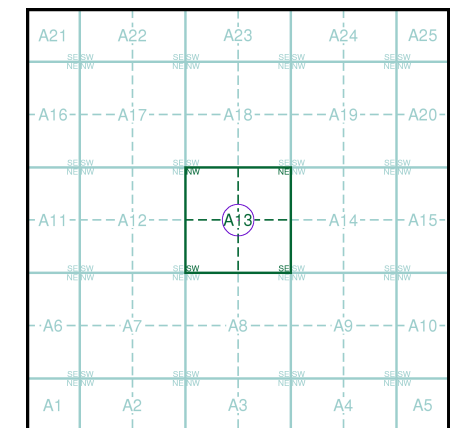

Order Details

Order Number: 159449760\_1\_1  
 Customer Ref: 555065, 179077  
 National Grid Reference: 555060, 179080  
 Slice: A  
 Site Area (Ha): 0.01  
 Search Buffer (m): 1000

Site Details

555065, 179077



Tel: 0844 844 9952  
 Fax: 0844 844 9951  
 Web: www.envirocheck.co.uk

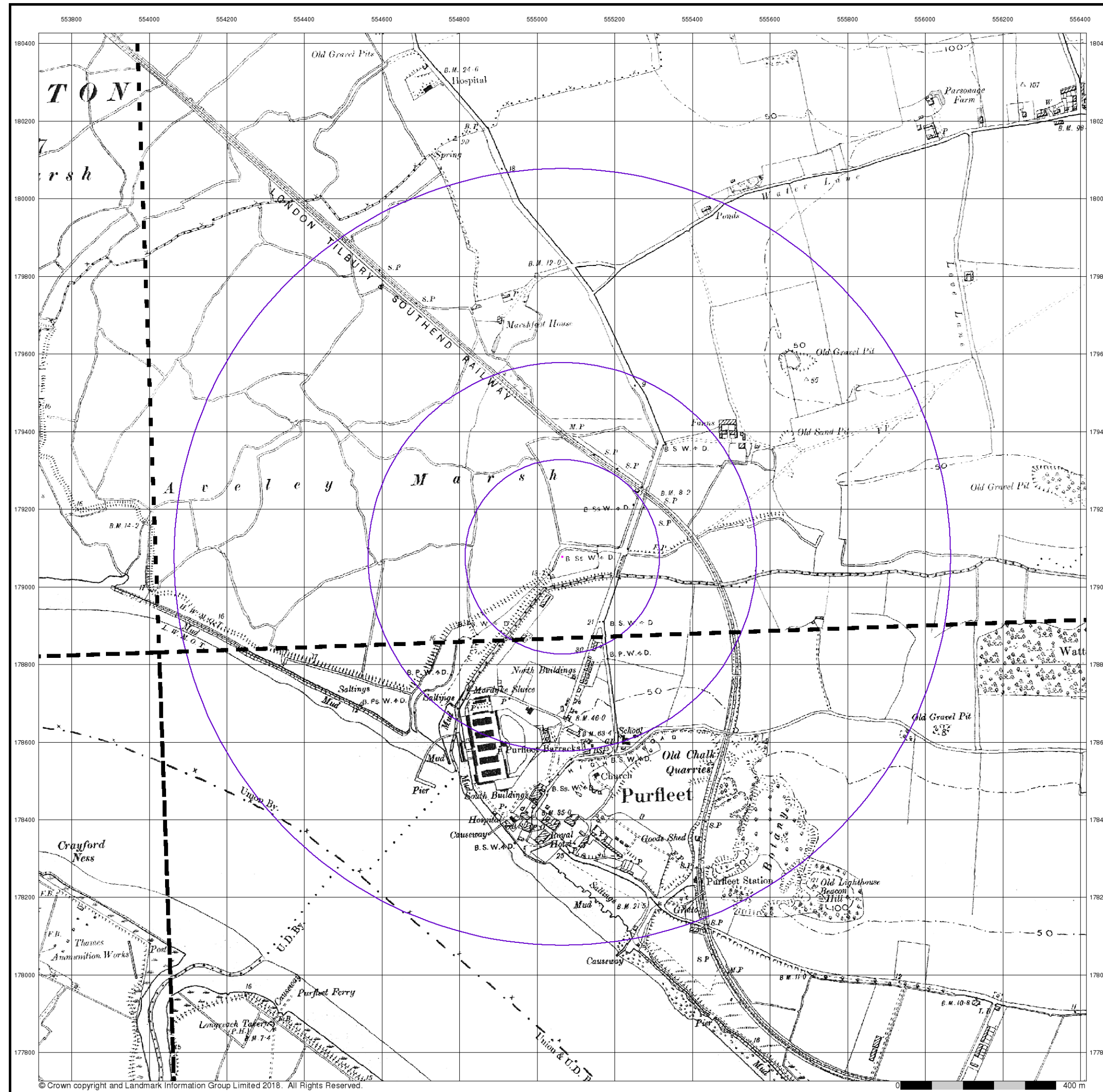

Essex

Published 1898 - 1899

Source map scale - 1:10,560

The historical maps shown were reproduced from maps predominantly held at the scale adopted for England, Wales and Scotland in the 1840's. In 1854 the 1:2,500 scale was adopted for mapping urban areas; these maps were used to update the 1:10,560 maps. The published date given therefore is often some years later than the surveyed date. Before 1938, all OS maps were based on the Cassini Projection, with independent surveys of a single county or group of counties, giving rise to significant inaccuracies in outlying areas. In the late 1940's, a Provisional Edition was produced, which updated the 1:10,560 mapping from a number of sources. The maps appear unfinished - with all military camps and other strategic sites removed. These maps were initially overprinted with the National Grid. In 1970, the first 1:10,000 maps were produced using the Transverse Mercator Projection. The revision process continued until recently, with new editions appearing every 10 years or so for urban areas.

Map Name(s) and Date(s)

082NE 1898 1:10,560	083NW 1898 1:10,560
082SE 1899 1:10,560	083SW 1898 1:10,560

Historical Map - Slice A

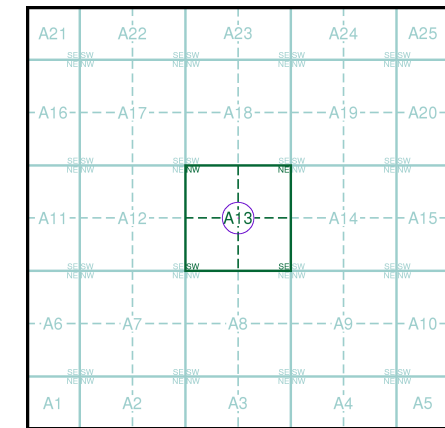

Order Details

Order Number: 159449760\_1\_1  
 Customer Ref: 555065, 179077  
 National Grid Reference: 555060, 179080  
 Slice: A  
 Site Area (Ha): 0.01  
 Search Buffer (m): 1000

Site Details

555065, 179077



Tel: 0844 844 9952  
 Fax: 0844 844 9951  
 Web: www.envirocheck.co.uk

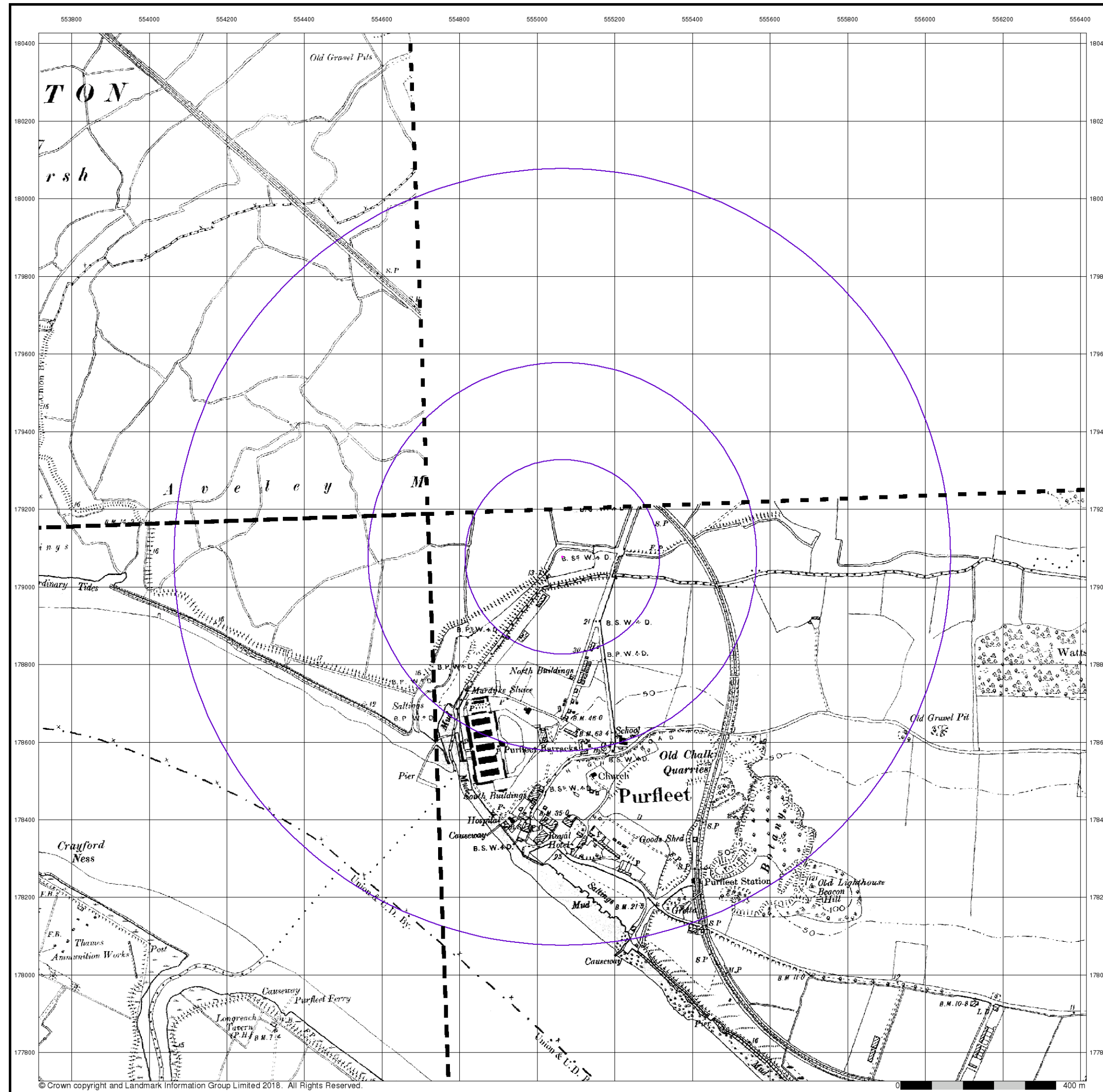

**Kent**

**Published 1898**

**Source map scale - 1:10,560**

The historical maps shown were reproduced from maps predominantly held at the scale adopted for England, Wales and Scotland in the 1840's. In 1854 the 1:2,500 scale was adopted for mapping urban areas; these maps were used to update the 1:10,560 maps. The published date given therefore is often some years later than the surveyed date. Before 1938, all OS maps were based on the Cassini Projection, with independent surveys of a single county or group of counties, giving rise to significant inaccuracies in outlying areas. In the late 1940's, a Provisional Edition was produced, which updated the 1:10,560 mapping from a number of sources. The maps appear unfinished - with all military camps and other strategic sites removed. These maps were initially overprinted with the National Grid. In 1970, the first 1:10,000 maps were produced using the Transverse Mercator Projection. The revision process continued until recently, with new editions appearing every 10 years or so for urban areas.

**Map Name(s) and Date(s)**

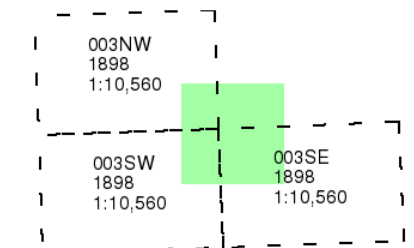

**Historical Map - Slice A**

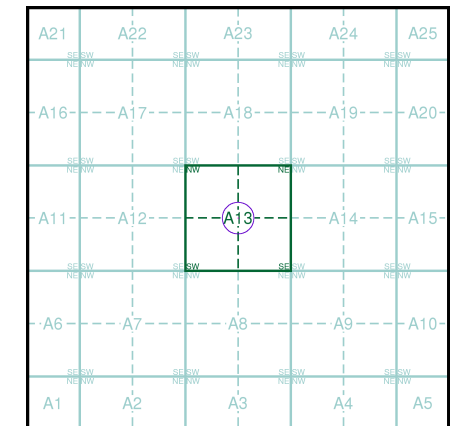

**Order Details**

Order Number: 159449760\_1\_1  
 Customer Ref: 555065, 179077  
 National Grid Reference: 555060, 179080  
 Slice: A  
 Site Area (Ha): 0.01  
 Search Buffer (m): 1000

**Site Details**

555065, 179077



Tel: 0844 844 9952  
 Fax: 0844 844 9951  
 Web: www.envirocheck.co.uk

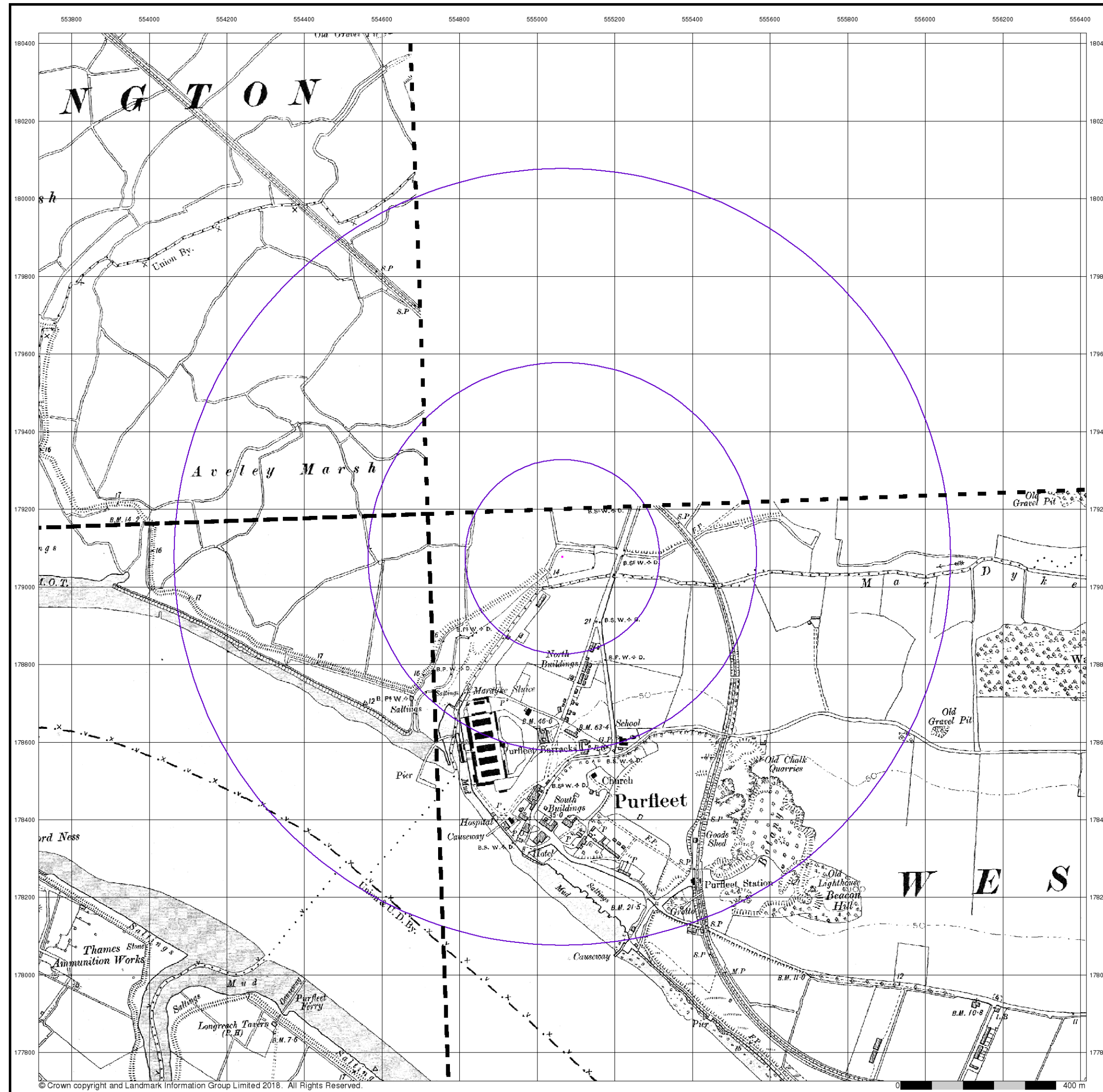

**Kent**

**Published 1910**

**Source map scale - 1:10,560**

The historical maps shown were reproduced from maps predominantly held at the scale adopted for England, Wales and Scotland in the 1840's. In 1854 the 1:2,500 scale was adopted for mapping urban areas; these maps were used to update the 1:10,560 maps. The published date given therefore is often some years later than the surveyed date. Before 1938, all OS maps were based on the Cassini Projection, with independent surveys of a single county or group of counties, giving rise to significant inaccuracies in outlying areas. In the late 1940's, a Provisional Edition was produced, which updated the 1:10,560 mapping from a number of sources. The maps appear unfinished - with all military camps and other strategic sites removed. These maps were initially overprinted with the National Grid. In 1970, the first 1:10,000 maps were produced using the Transverse Mercator Projection. The revision process continued until recently, with new editions appearing every 10 years or so for urban areas.

**Map Name(s) and Date(s)**

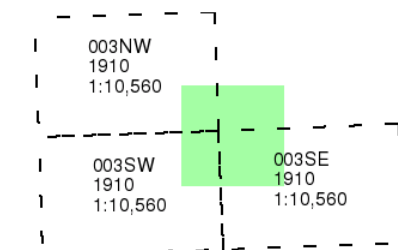

**Historical Map - Slice A**

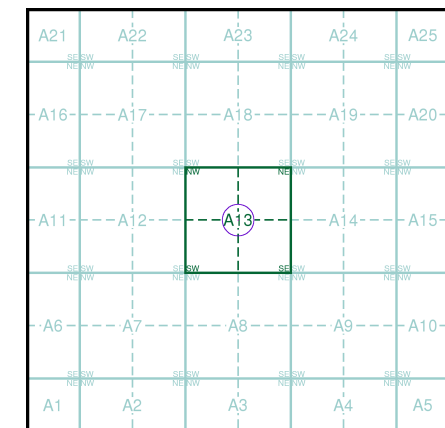

**Order Details**

Order Number: 159449760\_1\_1  
 Customer Ref: 555065, 179077  
 National Grid Reference: 555060, 179080  
 Slice: A  
 Site Area (Ha): 0.01  
 Search Buffer (m): 1000

**Site Details**

555065, 179077



Tel: 0844 844 9952  
 Fax: 0844 844 9951  
 Web: www.envirocheck.co.uk



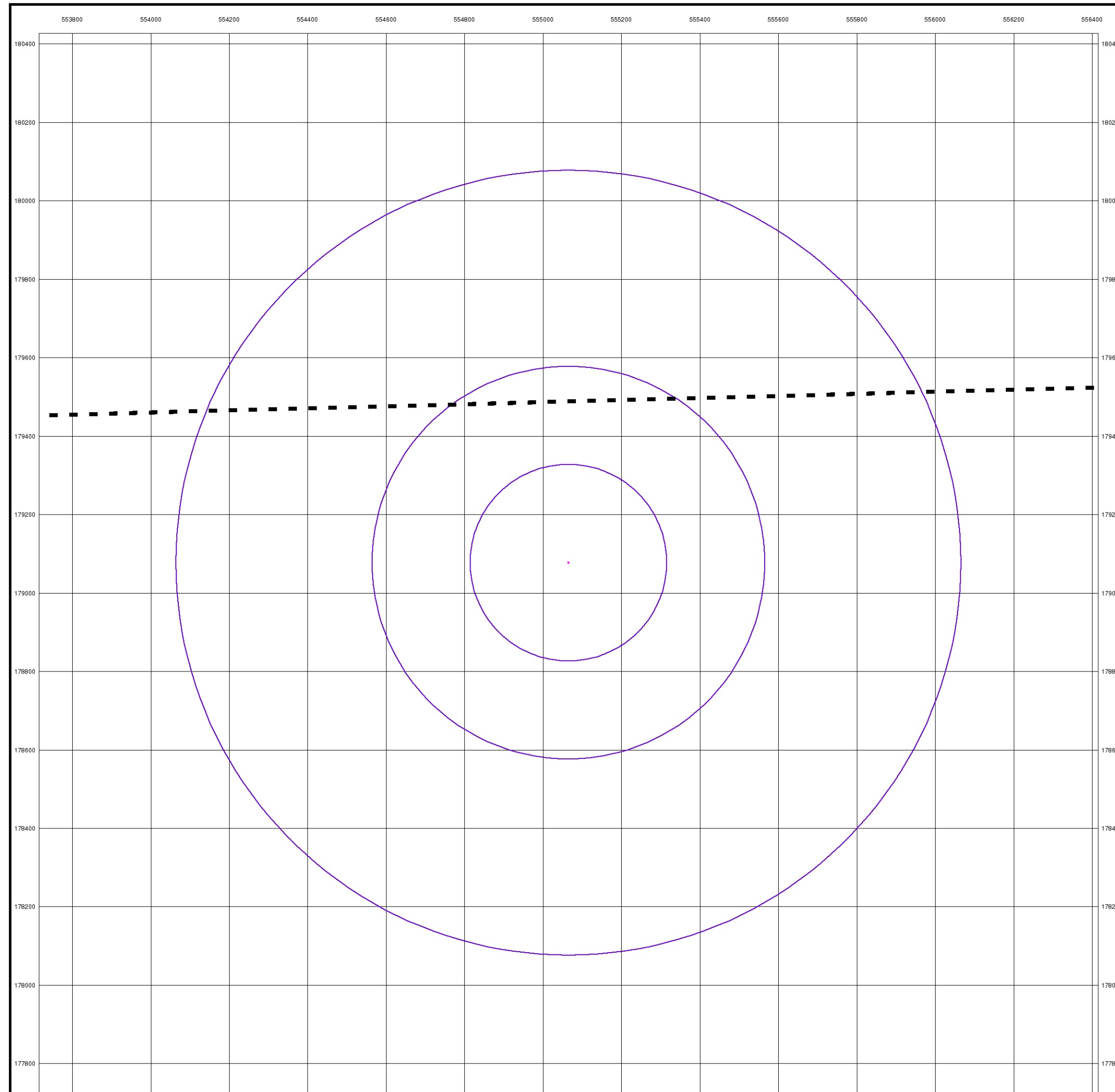

London

Published 1920

Source map scale - 1:10,560

The historical maps shown were reproduced from maps predominantly held at the scale adopted for England, Wales and Scotland in the 1840's. In 1854 the 1:2,500 scale was adopted for mapping urban areas; these maps were used to update the 1:10,560 maps. The published date given therefore is often some years later than the surveyed date. Before 1938, all OS maps were based on the Cassini Projection, with independent surveys of a single county or group of counties, giving rise to significant inaccuracies in outlying areas. In the late 1940's, a Provisional Edition was produced, which updated the 1:10,560 mapping from a number of sources. The maps appear unfinished - with all military camps and other strategic sites removed. These maps were initially overprinted with the National Grid. In 1970, the first 1:10,000 maps were produced using the Transverse Mercator Projection. The revision process continued until recently, with new editions appearing every 10 years or so for urban areas.

Map Name(s) and Date(s)

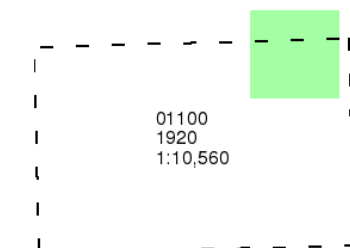

Historical Map - Slice A

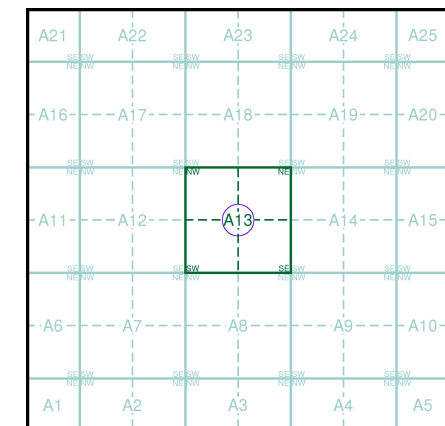

Order Details

Order Number: 159449760\_1\_1  
 Customer Ref: 555065, 179077  
 National Grid Reference: 555060, 179080  
 Slice: A  
 Site Area (Ha): 0.01  
 Search Buffer (m): 1000

Site Details

555065, 179077



Tel: 0844 844 9952  
 Fax: 0844 844 9951  
 Web: www.envirocheck.co.uk

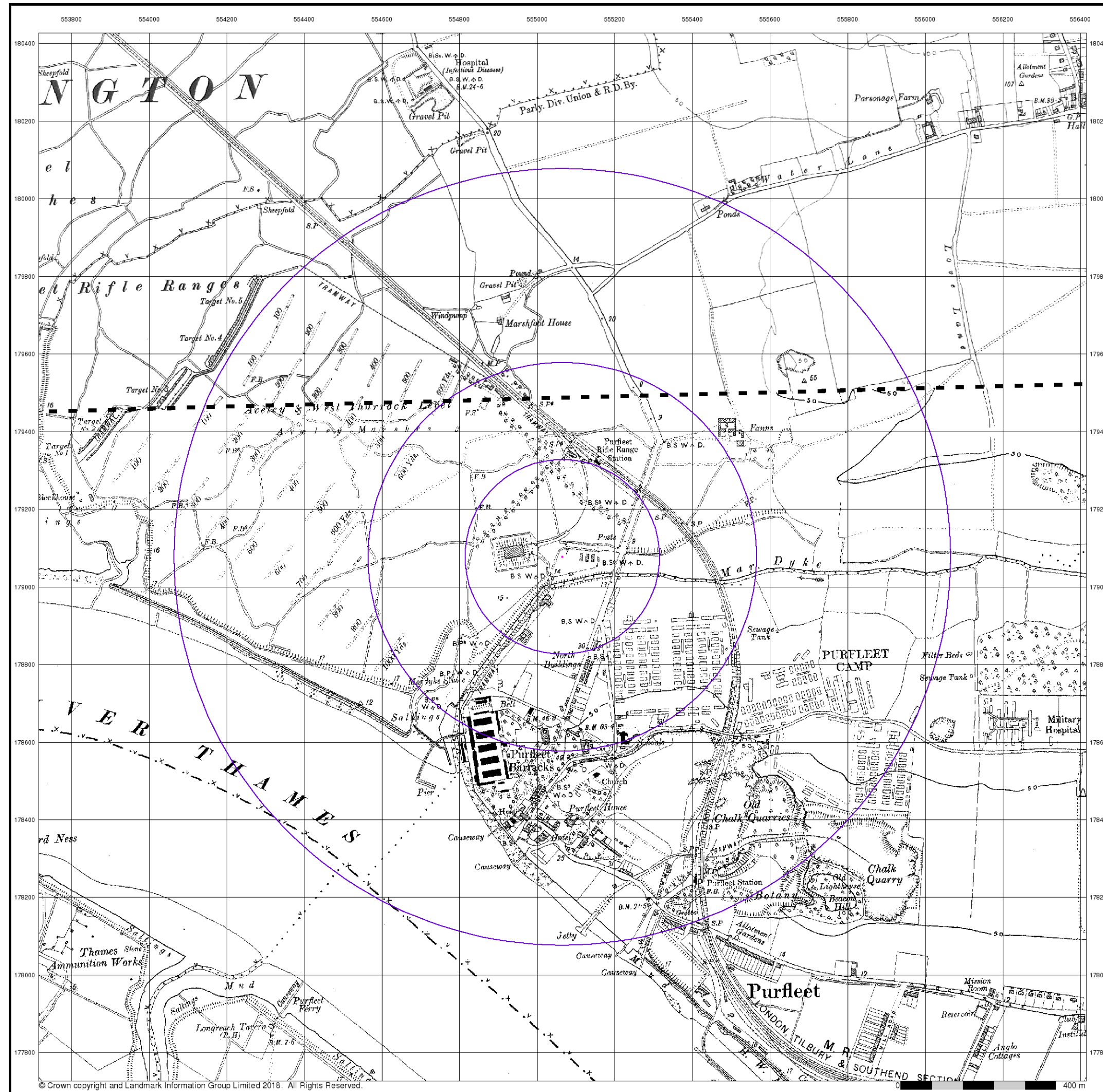

Essex

Published 1921

Source map scale - 1:10,560

The historical maps shown were reproduced from maps predominantly held at the scale adopted for England, Wales and Scotland in the 1840's. In 1854 the 1:2,500 scale was adopted for mapping urban areas; these maps were used to update the 1:10,560 maps. The published date given therefore is often some years later than the surveyed date. Before 1938, all OS maps were based on the Cassini Projection, with independent surveys of a single county or group of counties, giving rise to significant inaccuracies in outlying areas. In the late 1940's, a Provisional Edition was produced, which updated the 1:10,560 mapping from a number of sources. The maps appear unfinished - with all military camps and other strategic sites removed. These maps were initially overprinted with the National Grid. In 1970, the first 1:10,000 maps were produced using the Transverse Mercator Projection. The revision process continued until recently, with new editions appearing every 10 years or so for urban areas.

Map Name(s) and Date(s)

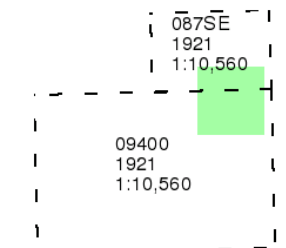

Historical Map - Slice A

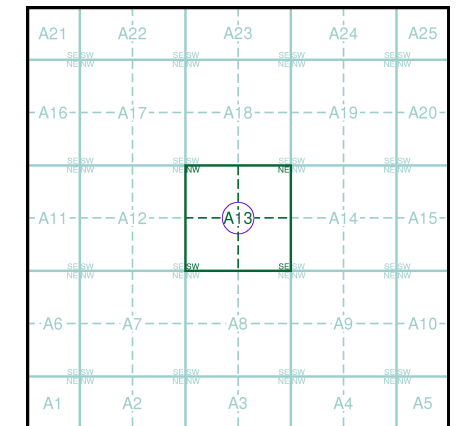

Order Details

Order Number: 159449760\_1\_1  
 Customer Ref: 555065, 179077  
 National Grid Reference: 555060, 179080  
 Slice: A  
 Site Area (Ha): 0.01  
 Search Buffer (m): 1000

Site Details

555065, 179077



Tel: 0844 844 9952  
 Fax: 0844 844 9951  
 Web: www.envirocheck.co.uk

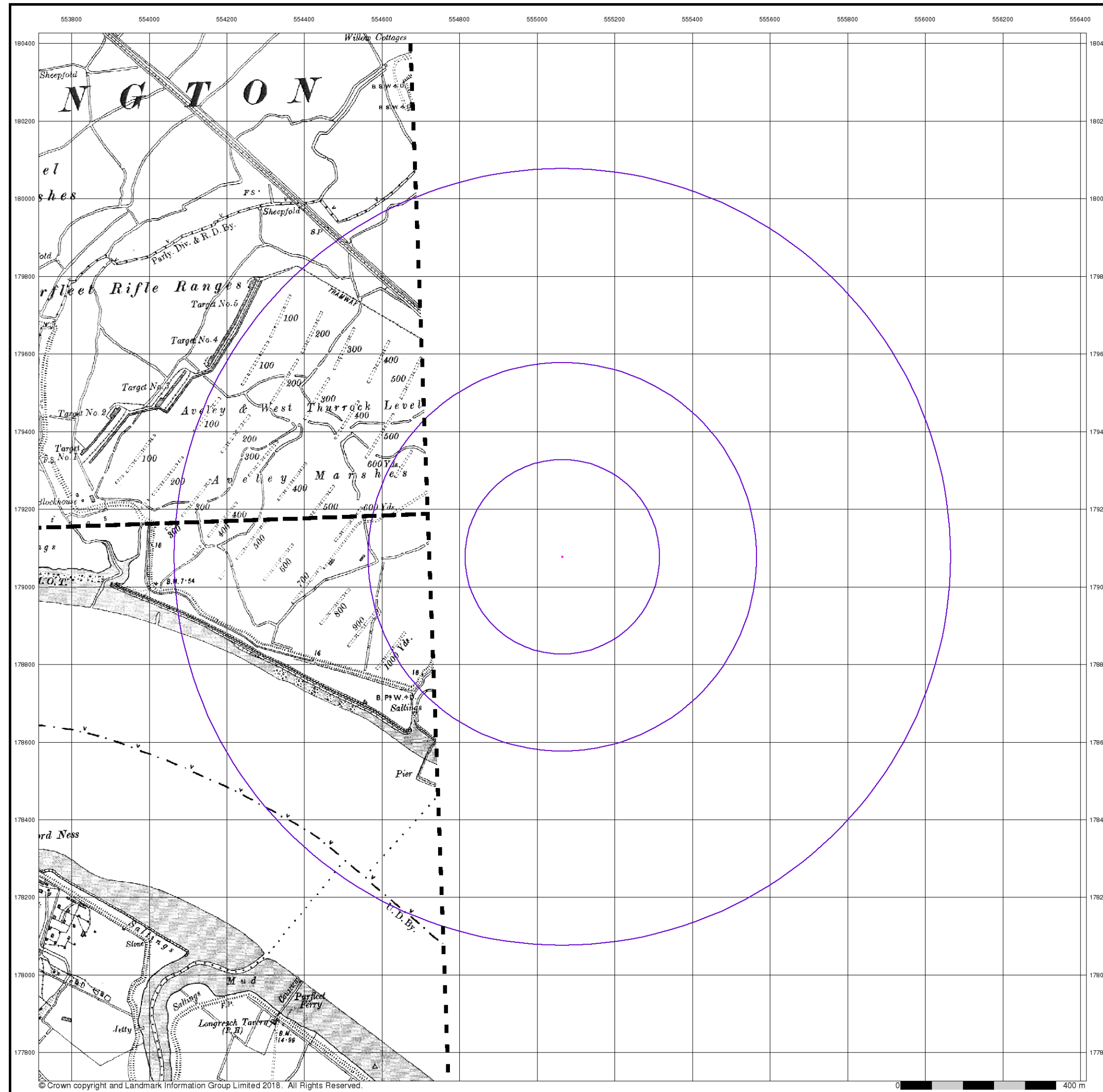

**Kent**

**Published 1931**

**Source map scale - 1:10,560**

The historical maps shown were reproduced from maps predominantly held at the scale adopted for England, Wales and Scotland in the 1840's. In 1854 the 1:2,500 scale was adopted for mapping urban areas; these maps were used to update the 1:10,560 maps. The published date given therefore is often some years later than the surveyed date. Before 1938, all OS maps were based on the Cassini Projection, with independent surveys of a single county or group of counties, giving rise to significant inaccuracies in outlying areas. In the late 1940's, a Provisional Edition was produced, which updated the 1:10,560 mapping from a number of sources. The maps appear unfinished - with all military camps and other strategic sites removed. These maps were initially overprinted with the National Grid. In 1970, the first 1:10,000 maps were produced using the Transverse Mercator Projection. The revision process continued until recently, with new editions appearing every 10 years or so for urban areas.

**Map Name(s) and Date(s)**

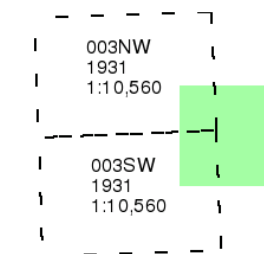

**Historical Map - Slice A**

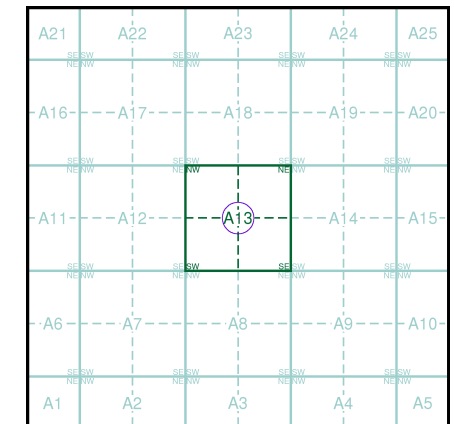

**Order Details**

Order Number: 159449760\_1\_1  
 Customer Ref: 555065, 179077  
 National Grid Reference: 555060, 179080  
 Slice: A  
 Site Area (Ha): 0.01  
 Search Buffer (m): 1000

**Site Details**

555065, 179077



Tel: 0844 844 9952  
 Fax: 0844 844 9951  
 Web: www.envirocheck.co.uk

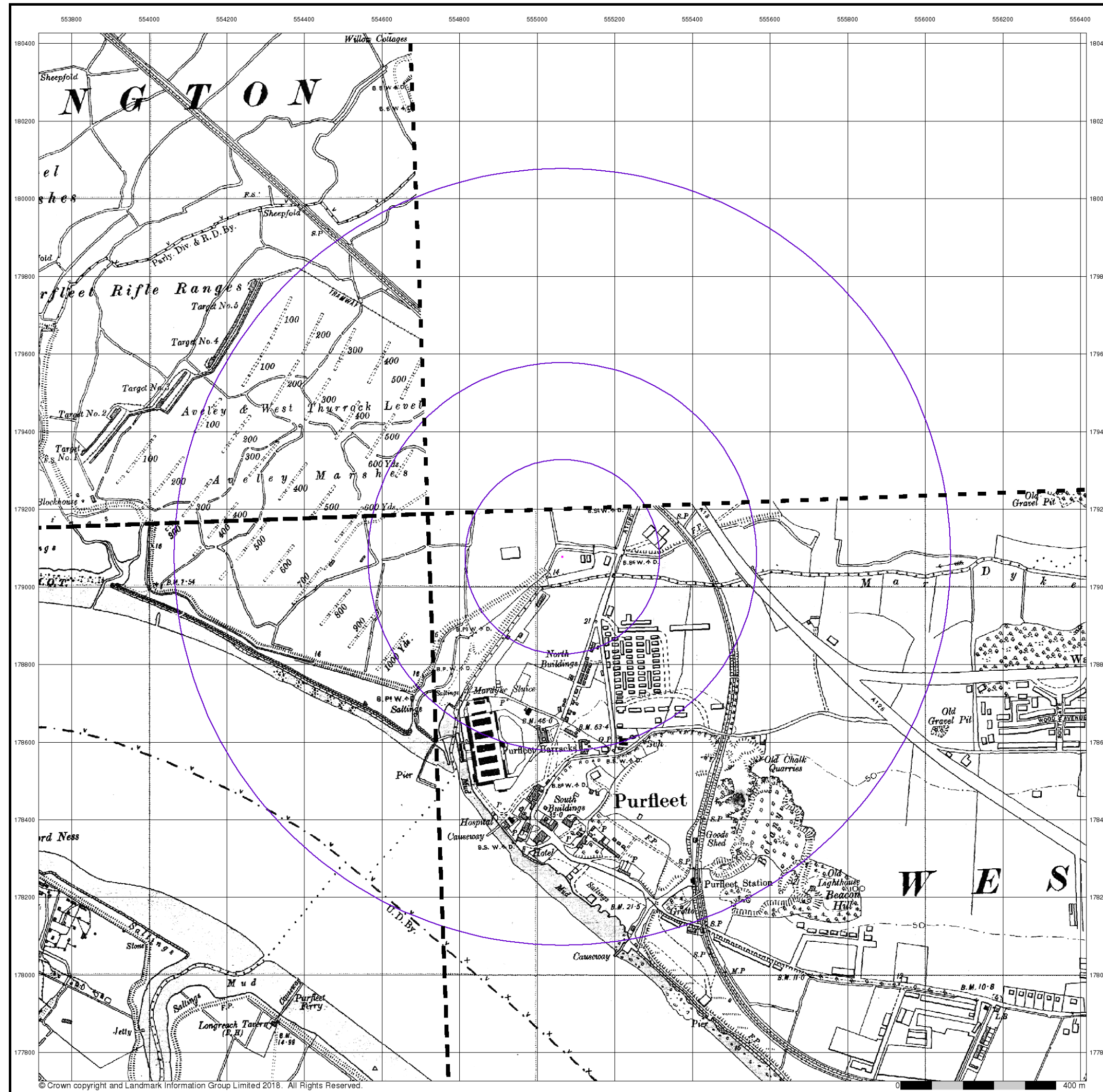

**Kent**

**Published 1938**

**Source map scale - 1:10,560**

The historical maps shown were reproduced from maps predominantly held at the scale adopted for England, Wales and Scotland in the 1840's. In 1854 the 1:2,500 scale was adopted for mapping urban areas; these maps were used to update the 1:10,560 maps. The published date given therefore is often some years later than the surveyed date. Before 1938, all OS maps were based on the Cassini Projection, with independent surveys of a single county or group of counties, giving rise to significant inaccuracies in outlying areas. In the late 1940's, a Provisional Edition was produced, which updated the 1:10,560 mapping from a number of sources. The maps appear unfinished - with all military camps and other strategic sites removed. These maps were initially overprinted with the National Grid. In 1970, the first 1:10,000 maps were produced using the Transverse Mercator Projection. The revision process continued until recently, with new editions appearing every 10 years or so for urban areas.

**Map Name(s) and Date(s)**

003NW 1938 1:10,560			
	003SW 1938 1:10,560	003SE 1938 1:10,560	

**Historical Map - Slice A**

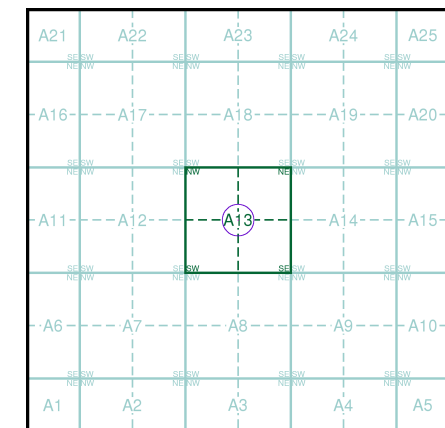

**Order Details**

Order Number: 159449760\_1\_1  
 Customer Ref: 555065, 179077  
 National Grid Reference: 555060, 179080  
 Slice: A  
 Site Area (Ha): 0.01  
 Search Buffer (m): 1000

**Site Details**

555065, 179077



Tel: 0844 844 9952  
 Fax: 0844 844 9951  
 Web: www.envirocheck.co.uk

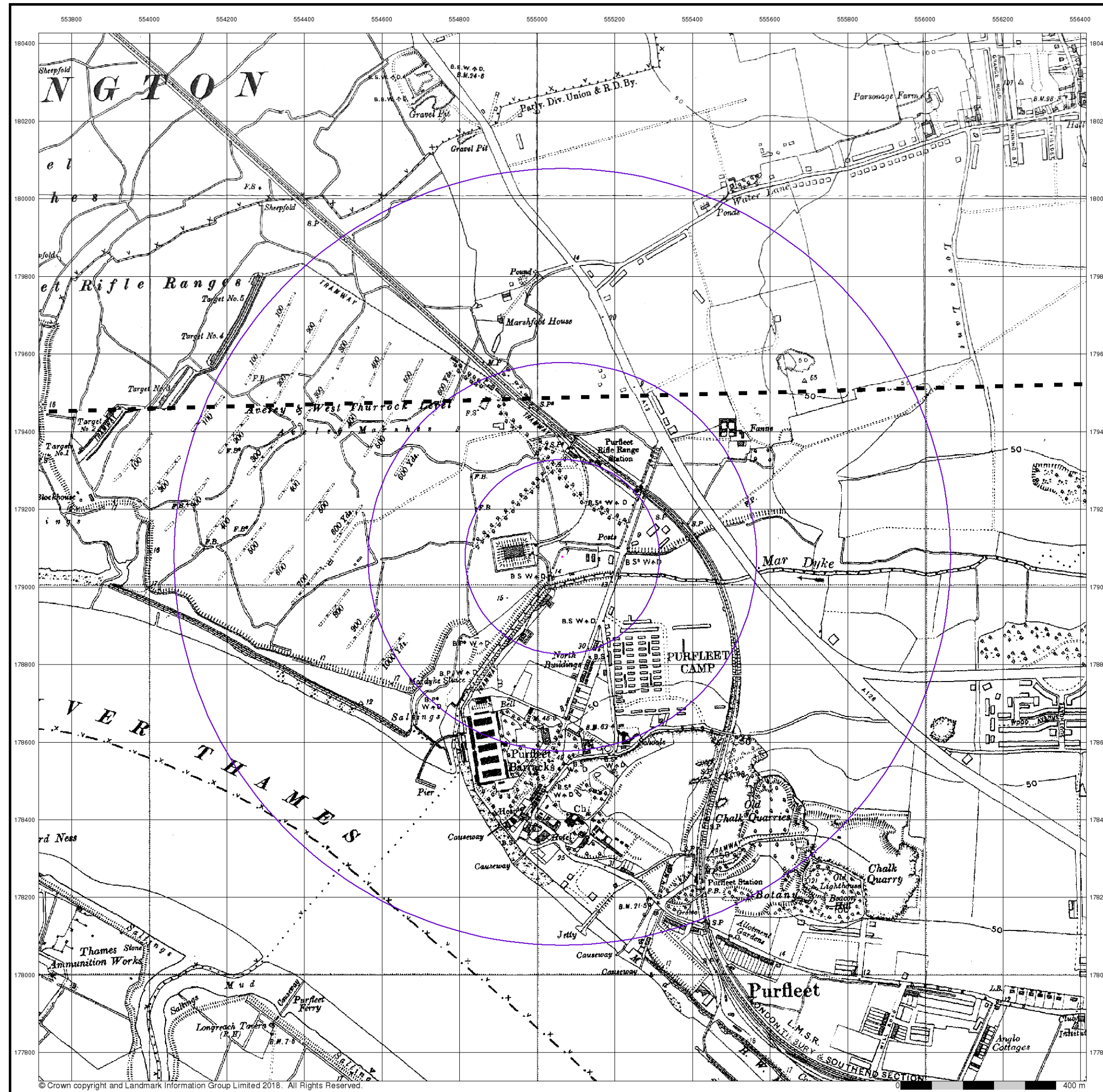

Essex

Published 1938

Source map scale - 1:10,560

The historical maps shown were reproduced from maps predominantly held at the scale adopted for England, Wales and Scotland in the 1840's. In 1854 the 1:2,500 scale was adopted for mapping urban areas; these maps were used to update the 1:10,560 maps. The published date given therefore is often some years later than the surveyed date. Before 1938, all OS maps were based on the Cassini Projection, with independent surveys of a single county or group of counties, giving rise to significant inaccuracies in outlying areas. In the late 1940's, a Provisional Edition was produced, which updated the 1:10,560 mapping from a number of sources. The maps appear unfinished - with all military camps and other strategic sites removed. These maps were initially overprinted with the National Grid. In 1970, the first 1:10,000 maps were produced using the Transverse Mercator Projection. The revision process continued until recently, with new editions appearing every 10 years or so for urban areas.

Map Name(s) and Date(s)

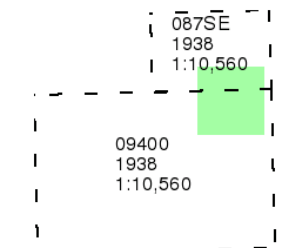

Historical Map - Slice A

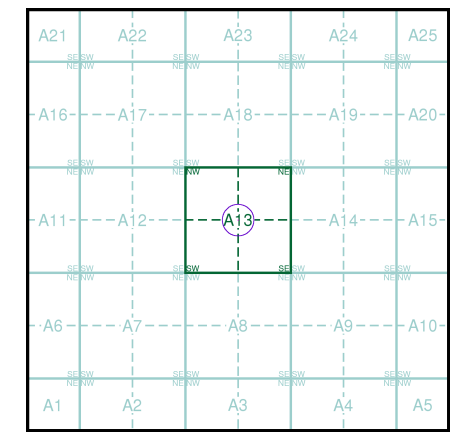

Order Details

Order Number: 159449760\_1\_1  
 Customer Ref: 555065, 179077  
 National Grid Reference: 555060, 179080  
 Slice: A  
 Site Area (Ha): 0.01  
 Search Buffer (m): 1000

Site Details

555065, 179077



Tel: 0844 844 9952  
 Fax: 0844 844 9951  
 Web: www.envirocheck.co.uk

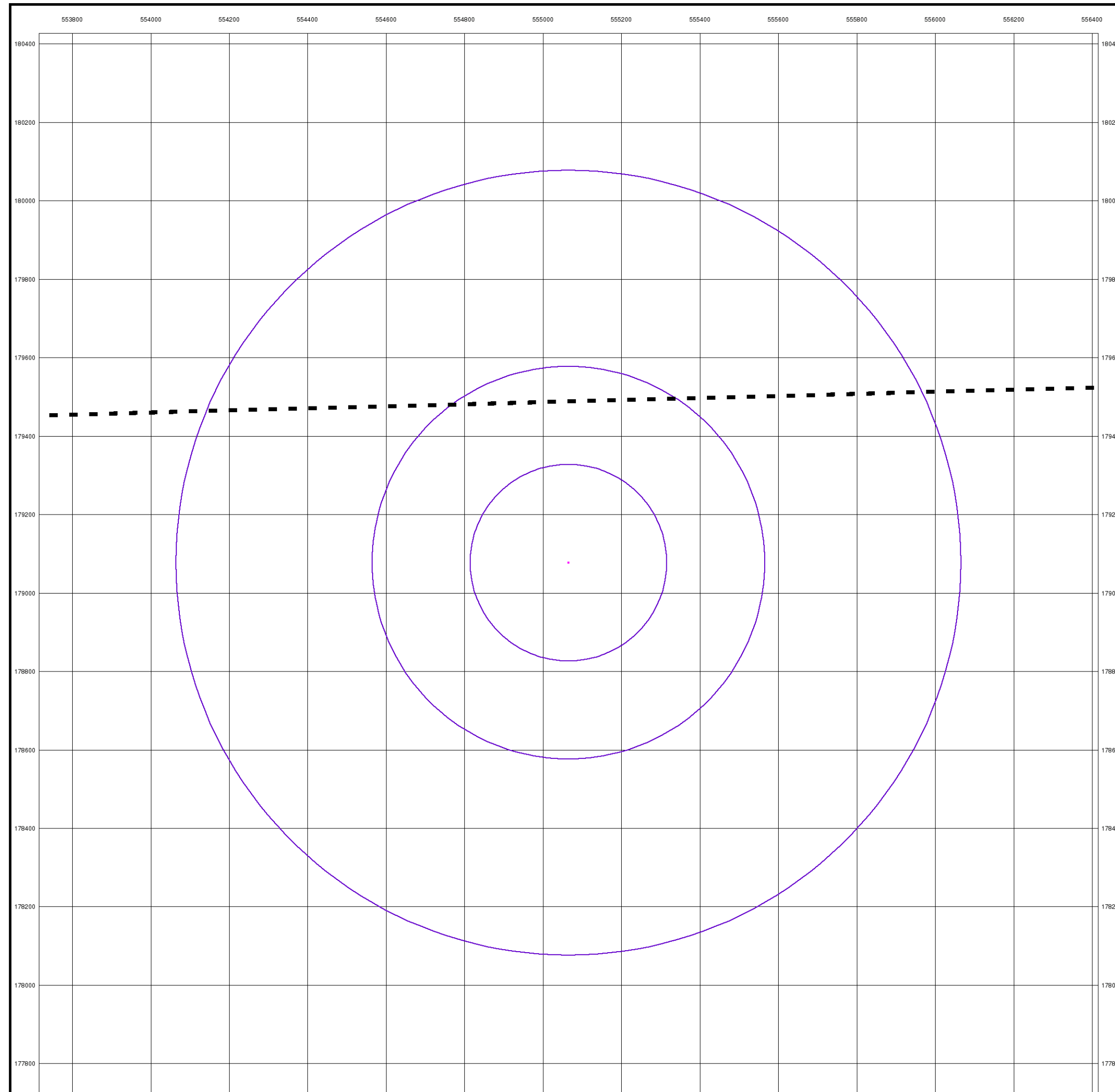

**London**

**Published 1938**

**Source map scale - 1:10,560**

The historical maps shown were reproduced from maps predominantly held at the scale adopted for England, Wales and Scotland in the 1840's. In 1854 the 1:2,500 scale was adopted for mapping urban areas; these maps were used to update the 1:10,560 maps. The published date given therefore is often some years later than the surveyed date. Before 1938, all OS maps were based on the Cassini Projection, with independent surveys of a single county or group of counties, giving rise to significant inaccuracies in outlying areas. In the late 1940's, a Provisional Edition was produced, which updated the 1:10,560 mapping from a number of sources. The maps appear unfinished - with all military camps and other strategic sites removed. These maps were initially overprinted with the National Grid. In 1970, the first 1:10,000 maps were produced using the Transverse Mercator Projection. The revision process continued until recently, with new editions appearing every 10 years or so for urban areas.

**Map Name(s) and Date(s)**

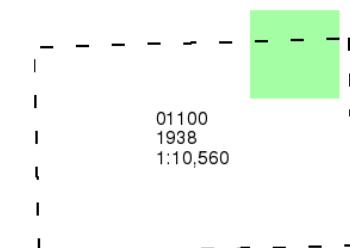

**Historical Map - Slice A**

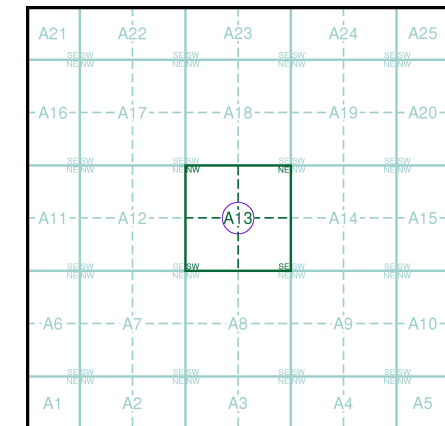

**Order Details**

Order Number: 159449760\_1\_1  
 Customer Ref: 555065, 179077  
 National Grid Reference: 555060, 179080  
 Slice: A  
 Site Area (Ha): 0.01  
 Search Buffer (m): 1000

**Site Details**

555065, 179077



Tel: 0844 844 9952  
 Fax: 0844 844 9951  
 Web: www.envirocheck.co.uk

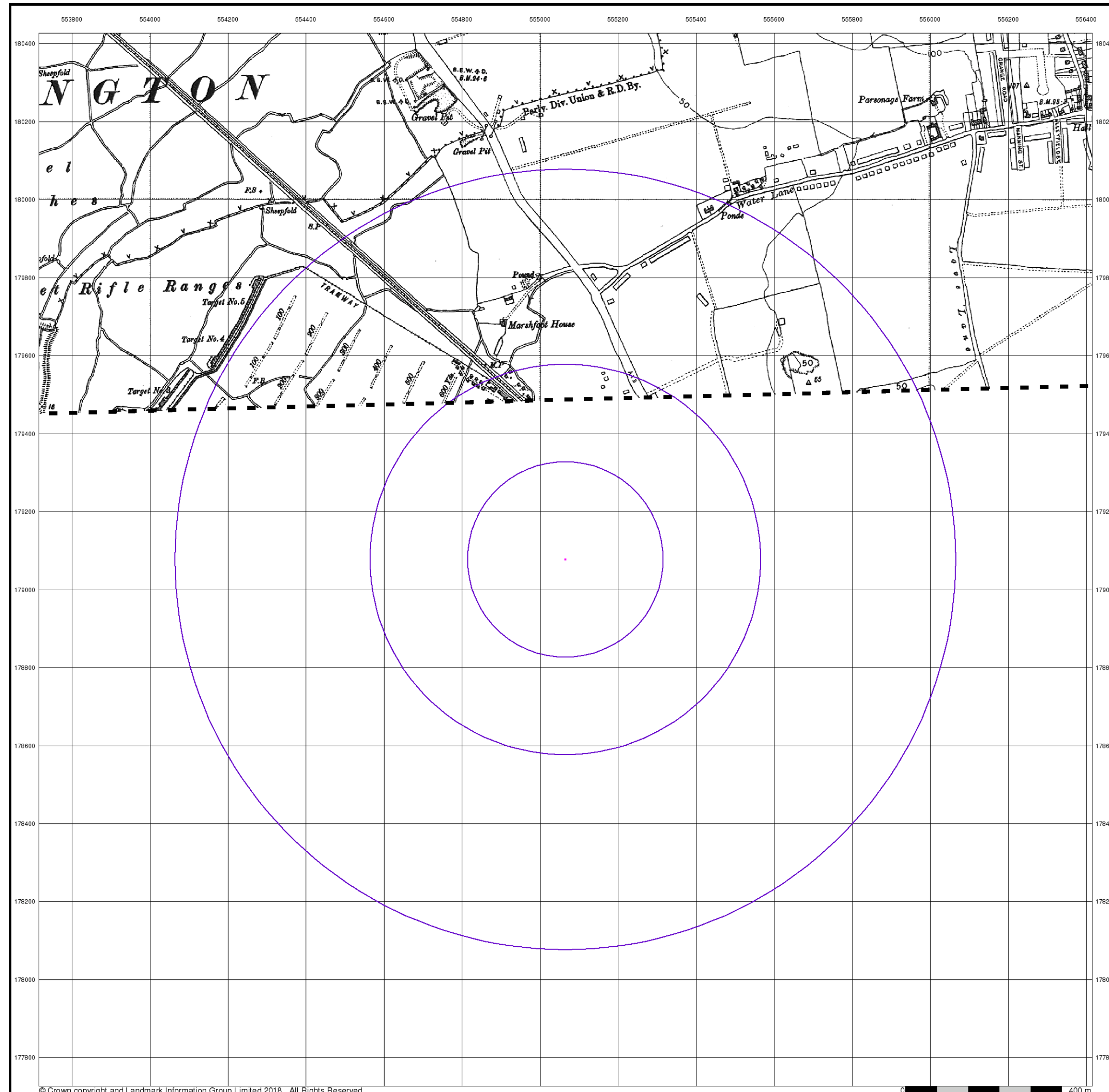

Essex

Published 1938

Source map scale - 1:10,560

The historical maps shown were reproduced from maps predominantly held at the scale adopted for England, Wales and Scotland in the 1840's. In 1854 the 1:2,500 scale was adopted for mapping urban areas; these maps were used to update the 1:10,560 maps. The published date given therefore is often some years later than the surveyed date. Before 1938, all OS maps were based on the Cassini Projection, with independent surveys of a single county or group of counties, giving rise to significant inaccuracies in outlying areas. In the late 1940's, a Provisional Edition was produced, which updated the 1:10,560 mapping from a number of sources. The maps appear unfinished - with all military camps and other strategic sites removed. These maps were initially overprinted with the National Grid. In 1970, the first 1:10,000 maps were produced using the Transverse Mercator Projection. The revision process continued until recently, with new editions appearing every 10 years or so for urban areas.

Map Name(s) and Date(s)

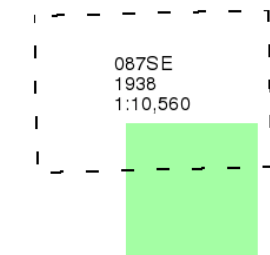

Historical Map - Slice A

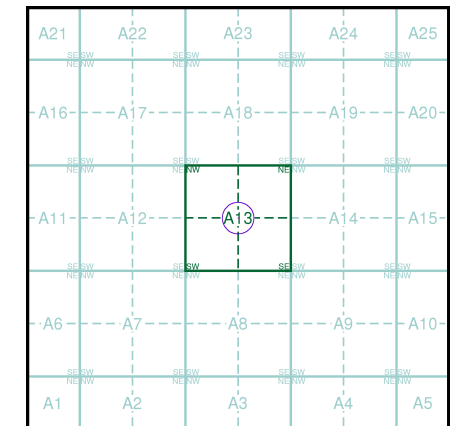

Order Details

Order Number: 159449760\_1\_1  
 Customer Ref: 555065, 179077  
 National Grid Reference: 555060, 179080  
 Slice: A  
 Site Area (Ha): 0.01  
 Search Buffer (m): 1000

Site Details

555065, 179077



Tel: 0844 844 9952  
 Fax: 0844 844 9951  
 Web: www.envirocheck.co.uk

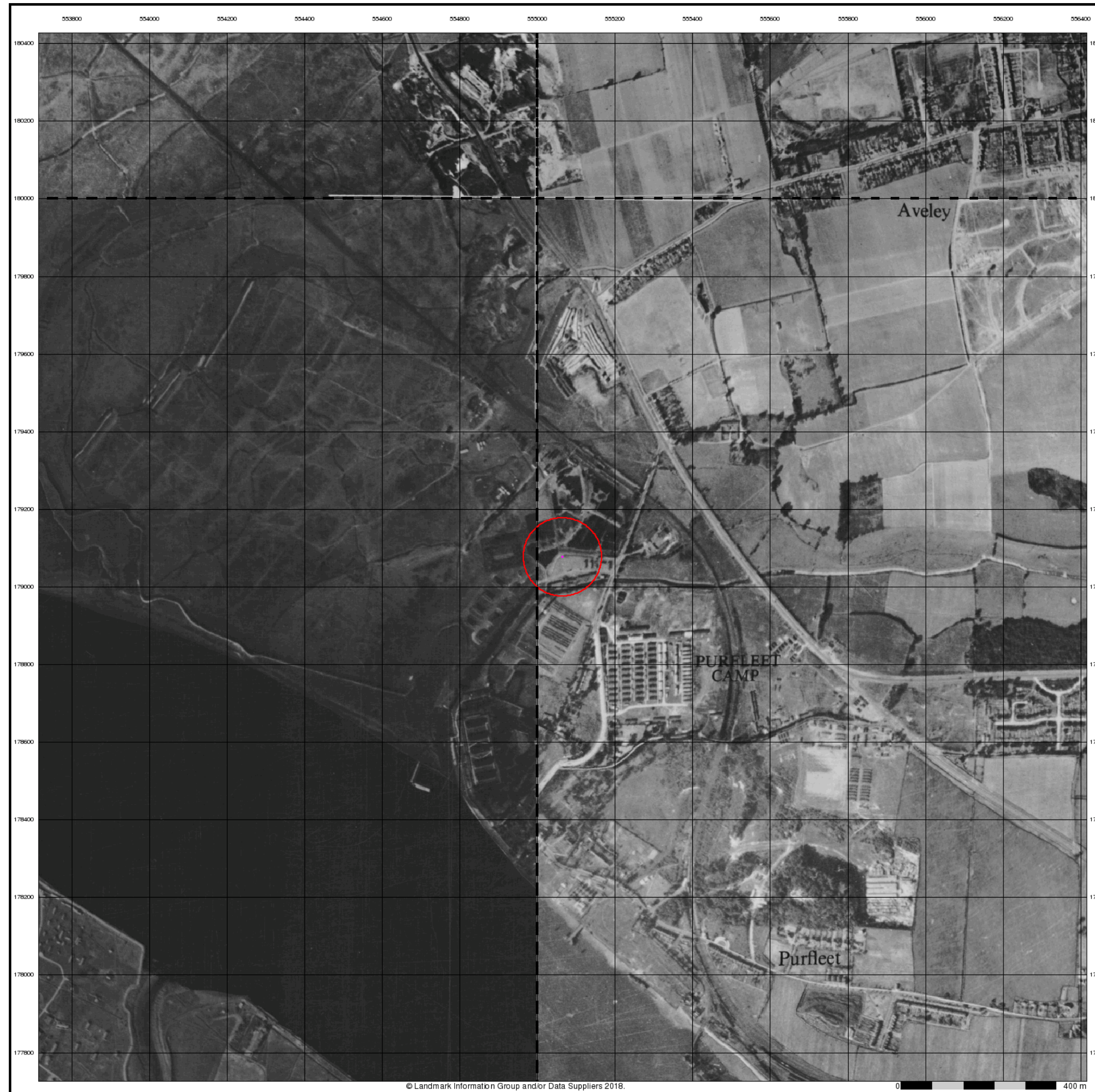

## Historical Aerial Photography

Published 1947 - 1949

Source map scale - 1:10,560

The Historical Aerial Photos were produced by the Ordnance Survey at a scale of 1:1,250 and 1:10,560 from Air Force photography. They were produced between 1944 and 1951 as an interim measure, pending preparation of conventional mapping, due to post war resource shortages. New security measures in the 1950's meant that every photograph was re-checked for potentially unsafe information with security sites replaced by fake fields or clouds. The original editions were withdrawn and only later made available after a period of fifty years although due to the accuracy of the editing, without viewing both revisions it is not easy to spot the edits. Where available Landmark have included both revisions.

© Landmark Information Group and/or Data Suppliers 2010.

### Map Name(s) and Date(s)

TQ58SW 1949 1:10,560	TQ58SE 1947 1:10,560
TQ57NW 1948 1:10,560	TQ57NE 1947 1:10,560

### Historical Aerial Photography - Slice A

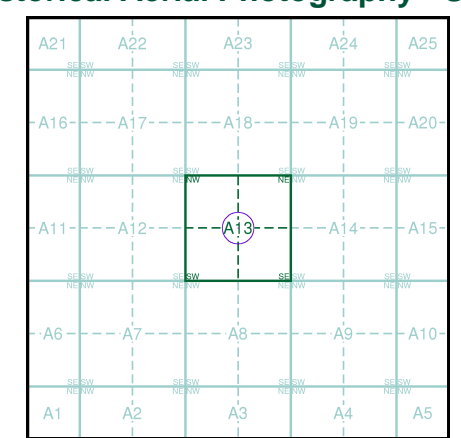

### Order Details

Order Number: 159449760\_1\_1  
 Customer Ref: 555065, 179077  
 National Grid Reference: 555060, 179080  
 Slice: A  
 Site Area (Ha): 0.01  
 Search Buffer (m): 1000

### Site Details

555065, 179077



Tel: 0844 844 9952  
 Fax: 0844 844 9951  
 Web: www.envirocheck.co.uk



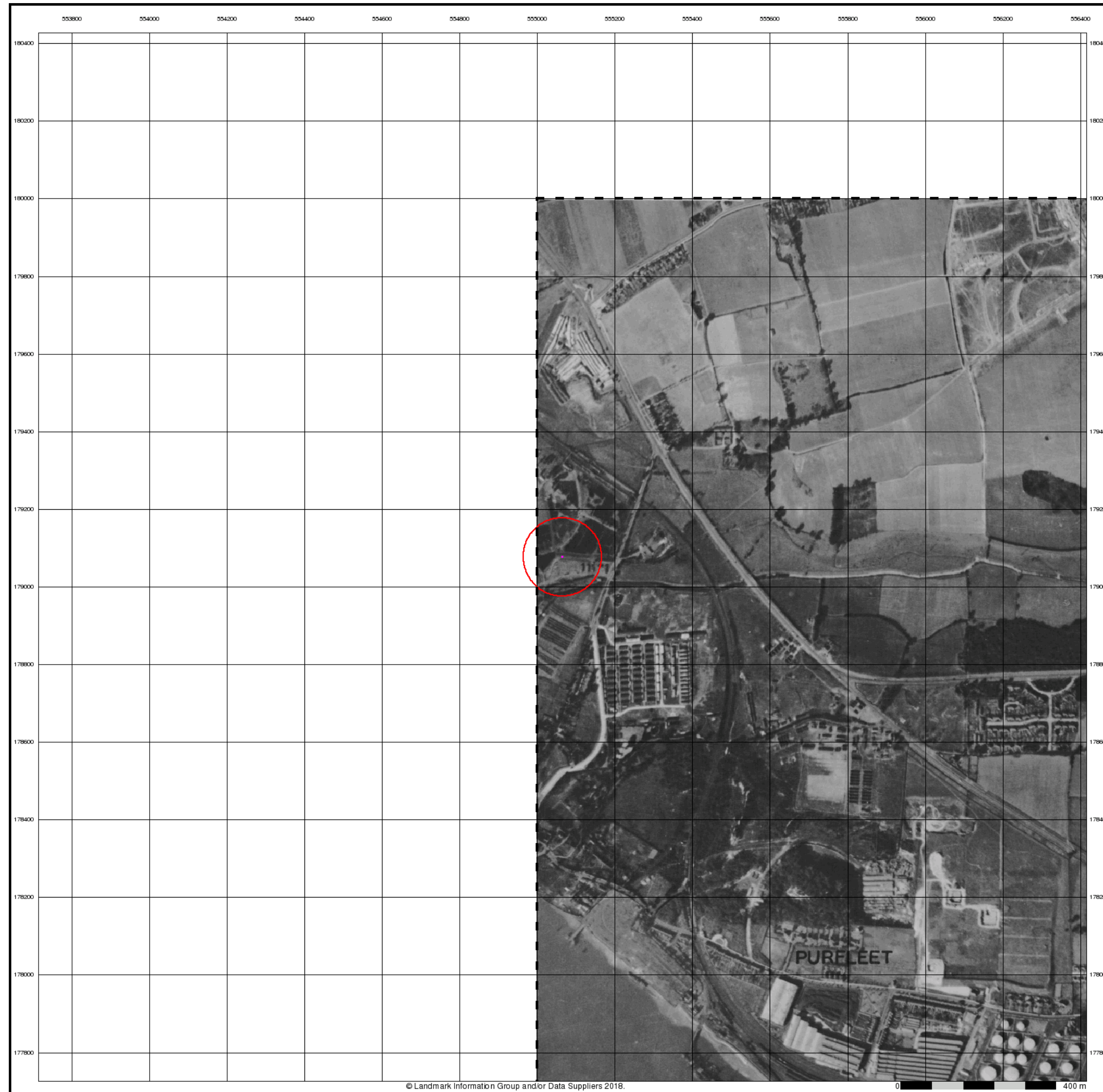

## Historical Aerial Photography

Published 1947

Source map scale - 1:10,560

The Historical Aerial Photos were produced by the Ordnance Survey at a scale of 1:1,250 and 1:10,560 from Air Force photography. They were produced between 1944 and 1951 as an interim measure, pending preparation of conventional mapping, due to post war resource shortages. New security measures in the 1950's meant that every photograph was re-checked for potentially unsafe information with security sites replaced by fake fields or clouds. The original editions were withdrawn and only later made available after a period of fifty years although due to the accuracy of the editing, without viewing both revisions it is not easy to spot the edits. Where available Landmark have included both revisions.

© Landmark Information Group and/or Data Suppliers 2010.

### Map Name(s) and Date(s)

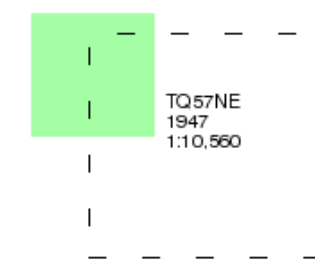

### Historical Aerial Photography - Slice A

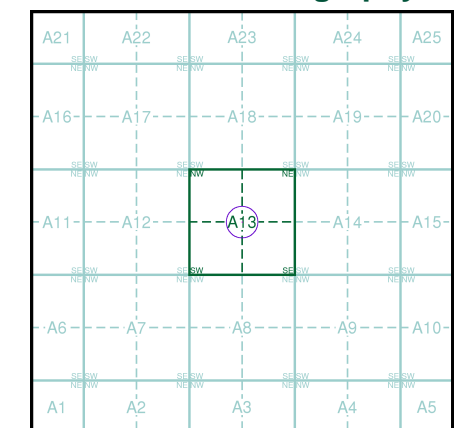

### Order Details

Order Number: 159449760\_1\_1  
 Customer Ref: 555065, 179077  
 National Grid Reference: 555060, 179080  
 Slice: A  
 Site Area (Ha): 0.01  
 Search Buffer (m): 1000

### Site Details

555065, 179077



Tel: 0844 844 9952  
 Fax: 0844 844 9951  
 Web: www.envirocheck.co.uk

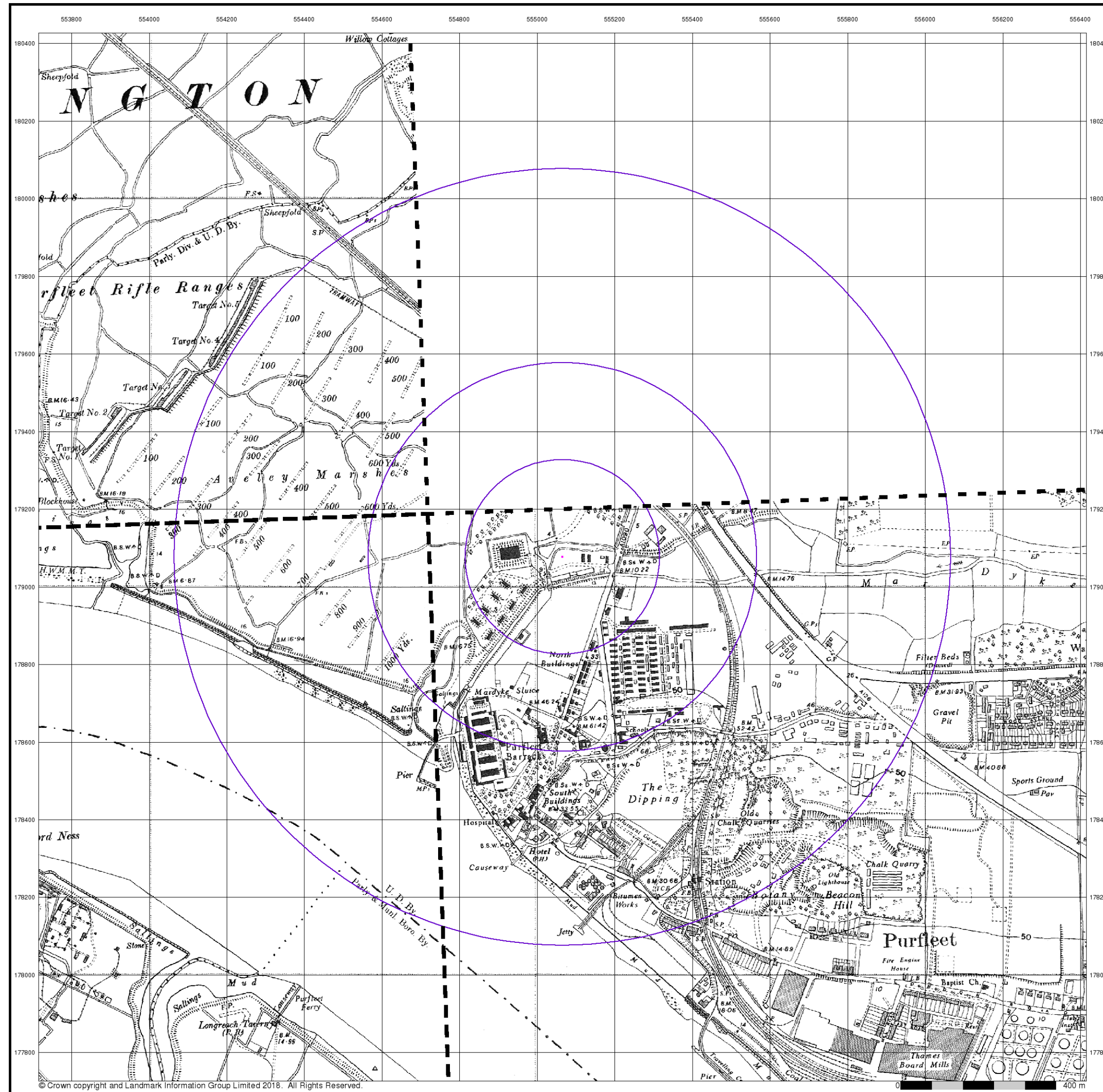

**Kent**

**Published 1950 - 1951**

**Source map scale - 1:10,560**

The historical maps shown were reproduced from maps predominantly held at the scale adopted for England, Wales and Scotland in the 1840's. In 1854 the 1:2,500 scale was adopted for mapping urban areas; these maps were used to update the 1:10,560 maps. The published date given therefore is often some years later than the surveyed date. Before 1938, all OS maps were based on the Cassini Projection, with independent surveys of a single county or group of counties, giving rise to significant inaccuracies in outlying areas. In the late 1940's, a Provisional Edition was produced, which updated the 1:10,560 mapping from a number of sources. The maps appear unfinished - with all military camps and other strategic sites removed. These maps were initially overprinted with the National Grid. In 1970, the first 1:10,000 maps were produced using the Transverse Mercator Projection. The revision process continued until recently, with new editions appearing every 10 years or so for urban areas.

**Map Name(s) and Date(s)**

003NW 1951 1:10,560			
003SW 1950 1:10,560		003SE 1951 1:10,560	

**Historical Map - Slice A**

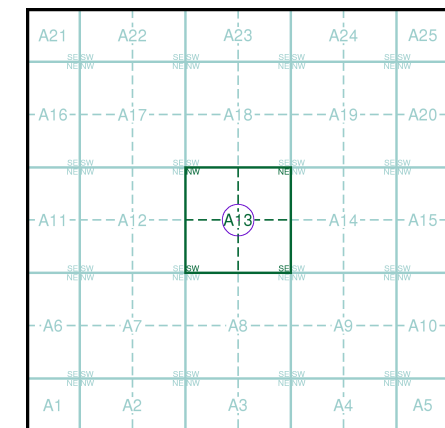

**Order Details**

Order Number: 159449760\_1\_1  
 Customer Ref: 555065, 179077  
 National Grid Reference: 555060, 179080  
 Slice: A  
 Site Area (Ha): 0.01  
 Search Buffer (m): 1000

**Site Details**

555065, 179077



Tel: 0844 844 9952  
 Fax: 0844 844 9951  
 Web: www.envirocheck.co.uk

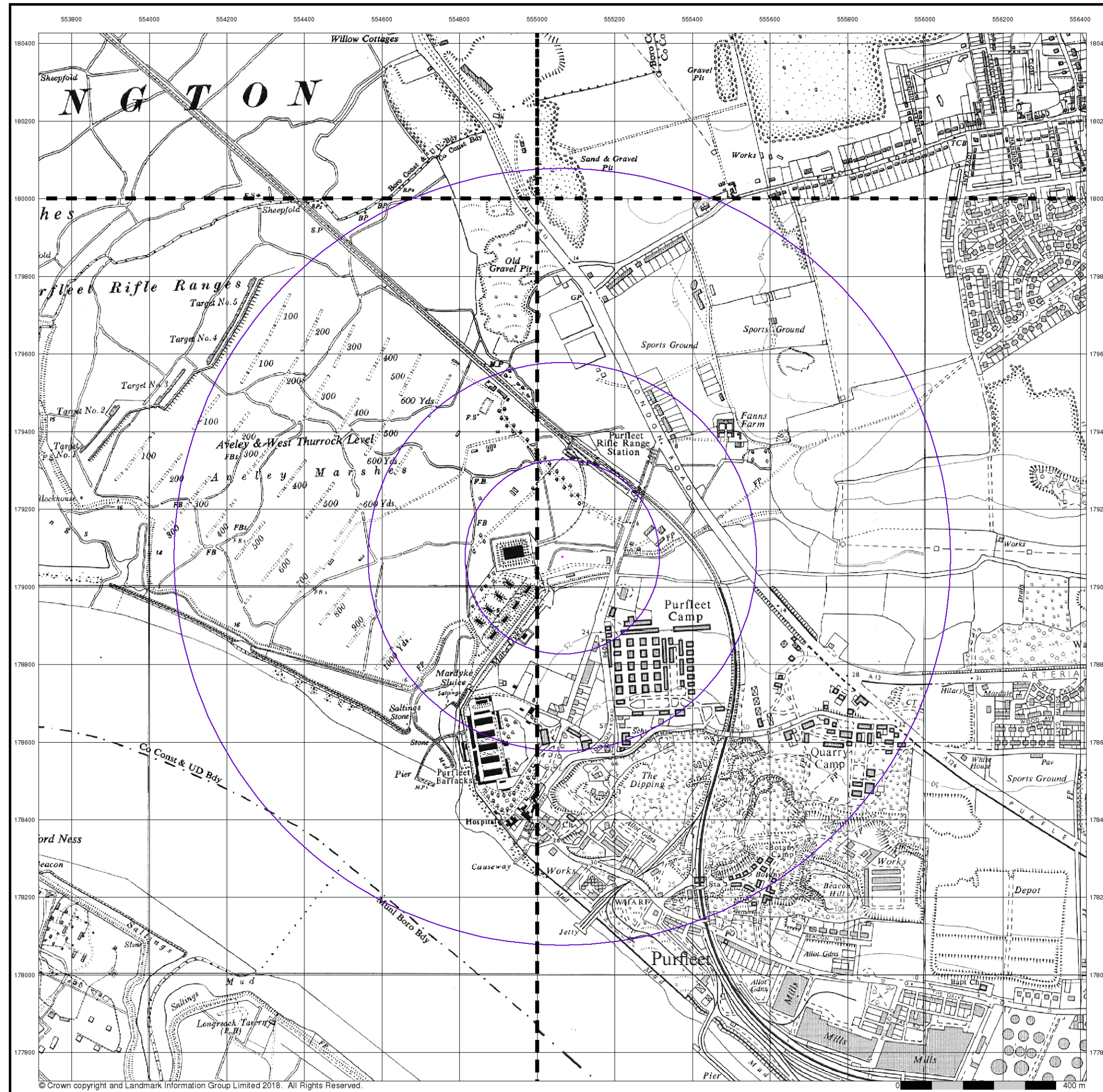

### Ordnance Survey Plan

Published 1961

Source map scale - 1:10,000

The historical maps shown were reproduced from maps predominantly held at the scale adopted for England, Wales and Scotland in the 1840's. In 1854 the 1:2,500 scale was adopted for mapping urban areas; these maps were used to update the 1:10,560 maps. The published date given therefore is often some years later than the surveyed date. Before 1938, all OS maps were based on the Cassini Projection, with independent surveys of a single county or group of counties, giving rise to significant inaccuracies in outlying areas. In the late 1940's, a Provisional Edition was produced, which updated the 1:10,560 mapping from a number of sources. The maps appear unfinished - with all military camps and other strategic sites removed. These maps were initially overprinted with the National Grid. In 1970, the first 1:10,000 maps were produced using the Transverse Mercator Projection. The revision process continued until recently, with new editions appearing every 10 years or so for urban areas.

### Map Name(s) and Date(s)

TQ58SW	TQ58SE
1961	1961
1:10,560	1:10,560
TQ57NW	TQ57NE
1961	1961
1:10,560	1:10,560

### Historical Map - Slice A

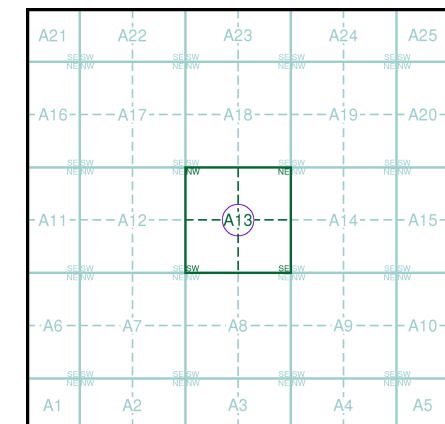

### Order Details

Order Number: 159449760\_1\_1  
 Customer Ref: 555065, 179077  
 National Grid Reference: 555060, 179080  
 Slice: A  
 Site Area (Ha): 0.01  
 Search Buffer (m): 1000

### Site Details

555065, 179077



Tel: 0844 844 9952  
 Fax: 0844 844 9951  
 Web: www.envirocheck.co.uk



**pba peterbrett**

**Ordnance Survey Plan**  
**Published 1966 - 1967**  
**Source map scale - 1:10,000**

The historical maps shown were reproduced from maps predominantly held at the scale adopted for England, Wales and Scotland in the 1840's. In 1854 the 1:2,500 scale was adopted for mapping urban areas; these maps were used to update the 1:10,560 maps. The published date given therefore is often some years later than the surveyed date. Before 1938, all OS maps were based on the Cassini Projection, with independent surveys of a single county or group of counties, giving rise to significant inaccuracies in outlying areas. In the late 1940's, a Provisional Edition was produced, which updated the 1:10,560 mapping from a number of sources. The maps appear unfinished - with all military camps and other strategic sites removed. These maps were initially overprinted with the National Grid. In 1970, the first 1:10,000 maps were produced using the Transverse Mercator Projection. The revision process continued until recently, with new editions appearing every 10 years or so for urban areas.

**Map Name(s) and Date(s)**

TQ58SW	TQ58SE
1967	1967
1:10,560	1:10,560
TQ57NW	TQ57NE
1967	1966
1:10,560	1:10,560

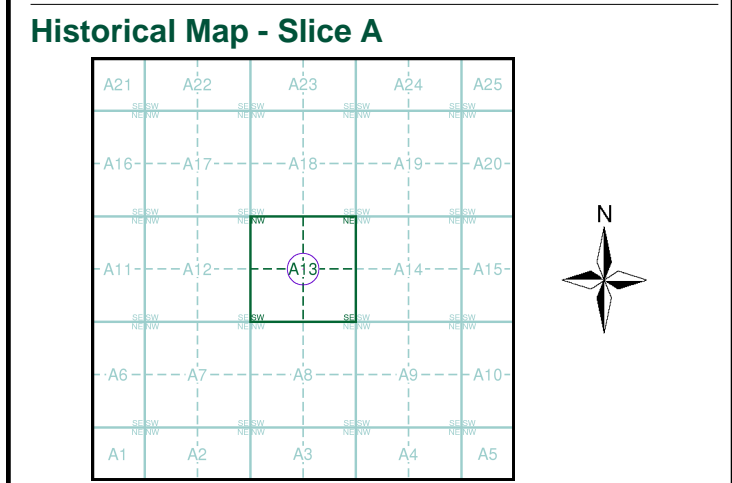

**Order Details**

Order Number: 159449760\_1\_1  
 Customer Ref: 555065, 179077  
 National Grid Reference: 555060, 179080  
 Slice: A  
 Site Area (Ha): 0.01  
 Search Buffer (m): 1000

**Site Details**  
 555065, 179077

**Landmark** INFORMATION GROUP

Tel: 0844 844 9952  
 Fax: 0844 844 9951  
 Web: www.envirocheck.co.uk

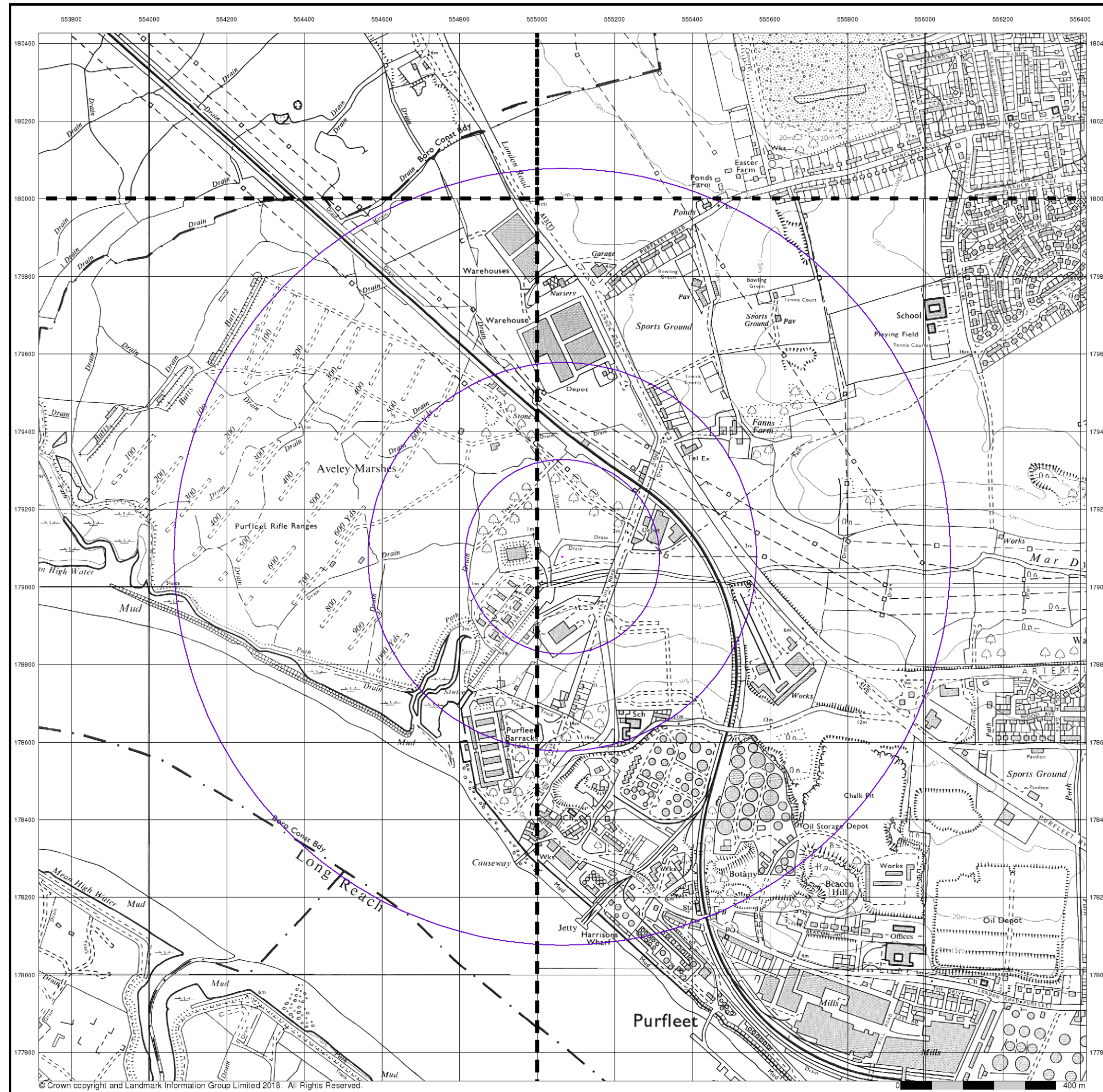

### Ordnance Survey Plan

Published 1975 - 1977

Source map scale - 1:10,000

The historical maps shown were reproduced from maps predominantly held at the scale adopted for England, Wales and Scotland in the 1840's. In 1854 the 1:2,500 scale was adopted for mapping urban areas; these maps were used to update the 1:10,560 maps. The published date given therefore is often some years later than the surveyed date. Before 1938, all OS maps were based on the Cassini Projection, with independent surveys of a single county or group of counties, giving rise to significant inaccuracies in outlying areas. In the late 1940's, a Provisional Edition was produced, which updated the 1:10,560 mapping from a number of sources. The maps appear unfinished - with all military camps and other strategic sites removed. These maps were initially overprinted with the National Grid. In 1970, the first 1:10,000 maps were produced using the Transverse Mercator Projection. The revision process continued until recently, with new editions appearing every 10 years or so for urban areas.

### Map Name(s) and Date(s)

TQ58SW	TQ58SE
1976	1975
1:10,000	1:10,000
TQ57NW	TQ57NE
1975	1977
1:10,000	1:10,000

### Historical Map - Slice A

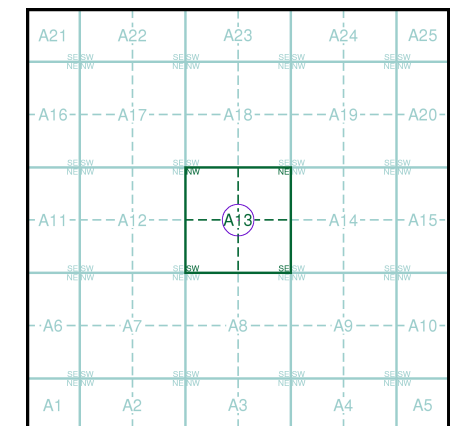

### Order Details

Order Number: 159449760\_1\_1  
 Customer Ref: 555065, 179077  
 National Grid Reference: 555060, 179080  
 Slice: A  
 Site Area (Ha): 0.01  
 Search Buffer (m): 1000

### Site Details

555065, 179077



Tel: 0844 844 9952  
 Fax: 0844 844 9951  
 Web: www.envirocheck.co.uk



**Gravesend**

**Published 1977**

**Source map scale - 1:10,000**

These maps were produced by the Russian military during the Cold War between 1950 and 1997, and cover 103 towns and cities throughout the U.K. The maps are produced at 1:25,000, 1:10,000 and 1:5,000 scale, and show detailed land use, with colour-coded areas for development, green areas, and non-developed areas. Buildings are coloured black and important building uses (such as hospitals, post offices, factories etc.) are numbered, with a numbered key describing their use.

They were produced by the Russians for the benefit of navigation, as well as strategic military sites and transport hubs, for use if they were to have invaded the U.K. The detailed information provided indicates that the areas were surveyed using land-based personnel, on the ground, in the cities that are mapped.

**Map Name(s) and Date(s)**

TQ58SW 1977 1:10,000	TQ58SE 1977 1:10,000
TQ57NW 1977 1:10,000	TQ57NE 1977 1:10,000

**Russian Map - Slice A**

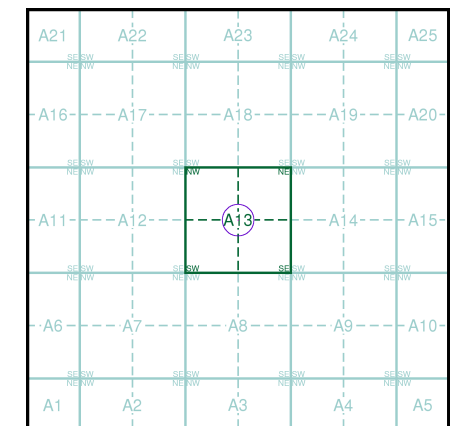

**Order Details**

Order Number: 159449760\_1\_1  
 Customer Ref: 555065, 179077  
 National Grid Reference: 555060, 179080  
 Slice: A  
 Site Area (Ha): 0.01  
 Search Buffer (m): 1000

**Site Details**

555065, 179077



Tel: 0844 844 9952  
 Fax: 0844 844 9951  
 Web: www.envirocheck.co.uk



London

Published 1985

Source map scale - 1:25,000

These maps were produced by the Russian military during the Cold War between 1950 and 1997, and cover 103 towns and cities throughout the U.K. The maps are produced at 1:25,000, 1:10,000 and 1:5,000 scale, and show detailed land use, with colour-coded areas for development, green areas, and non-developed areas. Buildings are coloured black and important building uses (such as hospitals, post offices, factories etc.) are numbered, with a numbered key describing their use.

They were produced by the Russians for the benefit of navigation, as well as strategic military sites and transport hubs, for use if they were to have invaded the U.K. The detailed information provided indicates that the areas were surveyed using land-based personnel, on the ground, in the cities that are mapped.

Map Name(s) and Date(s)

TQ58	1985	1:25,000
TQ57	1985	1:25,000

Russian Map - Slice A

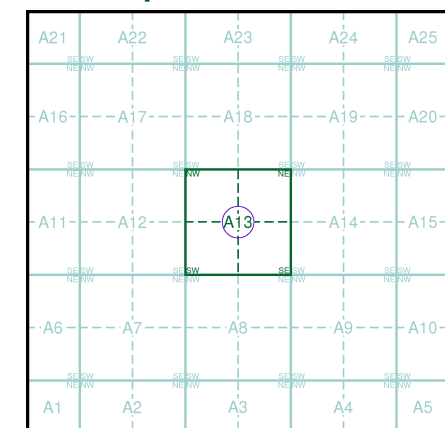

Order Details

Order Number: 159449760\_1\_1  
 Customer Ref: 555065, 179077  
 National Grid Reference: 555060, 179080  
 Slice: A  
 Site Area (Ha): 0.01  
 Search Buffer (m): 1000

Site Details

555065, 179077



Tel: 0844 844 9952  
 Fax: 0844 844 9951  
 Web: www.envirocheck.co.uk



**Ordnance Survey Plan**

**Published 1987 - 1989**

**Source map scale - 1:10,000**

The historical maps shown were reproduced from maps predominantly held at the scale adopted for England, Wales and Scotland in the 1840's. In 1854 the 1:2,500 scale was adopted for mapping urban areas; these maps were used to update the 1:10,560 maps. The published date given therefore is often some years later than the surveyed date. Before 1938, all OS maps were based on the Cassini Projection, with independent surveys of a single county or group of counties, giving rise to significant inaccuracies in outlying areas. In the late 1940's, a Provisional Edition was produced, which updated the 1:10,560 mapping from a number of sources. The maps appear unfinished - with all military camps and other strategic sites removed. These maps were initially overprinted with the National Grid. In 1970, the first 1:10,000 maps were produced using the Transverse Mercator Projection. The revision process continued until recently, with new editions appearing every 10 years or so for urban areas.

**Map Name(s) and Date(s)**

TQ58SE	1989	1:10,000
TQ57NW	1987	1:10,000
TQ57NE	1987	1:10,000

**Historical Map - Slice A**

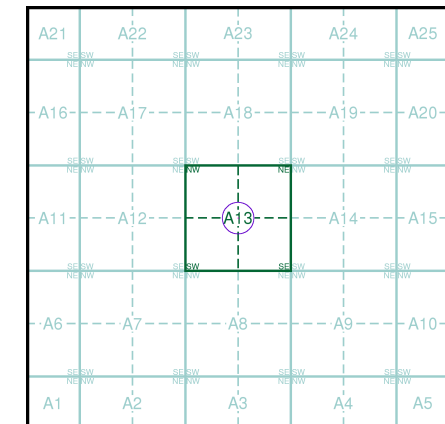

**Order Details**

Order Number: 159449760\_1\_1  
 Customer Ref: 555065, 179077  
 National Grid Reference: 555060, 179080  
 Slice: A  
 Site Area (Ha): 0.01  
 Search Buffer (m): 1000

**Site Details**

555065, 179077



Tel: 0844 844 9952  
 Fax: 0844 844 9951  
 Web: www.envirocheck.co.uk





### Ordnance Survey Plan

Published 1993 - 1996

Source map scale - 1:10,000

The historical maps shown were reproduced from maps predominantly held at the scale adopted for England, Wales and Scotland in the 1840's. In 1854 the 1:2,500 scale was adopted for mapping urban areas; these maps were used to update the 1:10,560 maps. The published date given therefore is often some years later than the surveyed date. Before 1938, all OS maps were based on the Cassini Projection, with independent surveys of a single county or group of counties, giving rise to significant inaccuracies in outlying areas. In the late 1940's, a Provisional Edition was produced, which updated the 1:10,560 mapping from a number of sources. The maps appear unfinished - with all military camps and other strategic sites removed. These maps were initially overprinted with the National Grid. In 1970, the first 1:10,000 maps were produced using the Transverse Mercator Projection. The revision process continued until recently, with new editions appearing every 10 years or so for urban areas.

### Map Name(s) and Date(s)

TQ58SW	1993	1:10,000
TQ57NW	1996	1:10,000
TQ57NE	1993	1:10,000

### Historical Map - Slice A

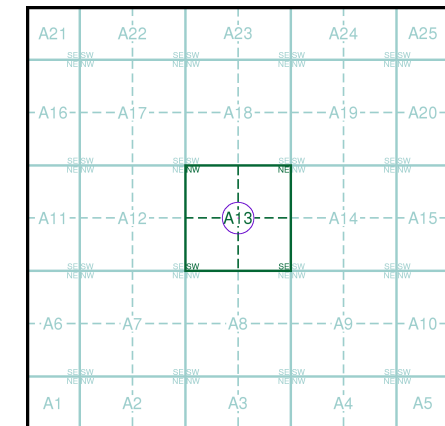

### Order Details

Order Number: 159449760\_1\_1  
 Customer Ref: 555065, 179077  
 National Grid Reference: 555060, 179080  
 Slice: A  
 Site Area (Ha): 0.01  
 Search Buffer (m): 1000

### Site Details

555065, 179077



Tel: 0844 844 9952  
 Fax: 0844 844 9951  
 Web: www.envirocheck.co.uk



## Ordnance Survey Plan

Published 1996

Source map scale - 1:10,000

The historical maps shown were reproduced from maps predominantly held at the scale adopted for England, Wales and Scotland in the 1840's. In 1854 the 1:2,500 scale was adopted for mapping urban areas; these maps were used to update the 1:10,560 maps. The published date given therefore is often some years later than the surveyed date. Before 1938, all OS maps were based on the Cassini Projection, with independent surveys of a single county or group of counties, giving rise to significant inaccuracies in outlying areas. In the late 1940's, a Provisional Edition was produced, which updated the 1:10,560 mapping from a number of sources. The maps appear unfinished - with all military camps and other strategic sites removed. These maps were initially overprinted with the National Grid. In 1970, the first 1:10,000 maps were produced using the Transverse Mercator Projection. The revision process continued until recently, with new editions appearing every 10 years or so for urban areas.

### Map Name(s) and Date(s)

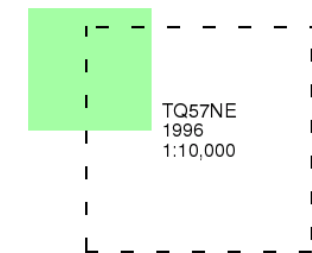

### Historical Map - Slice A

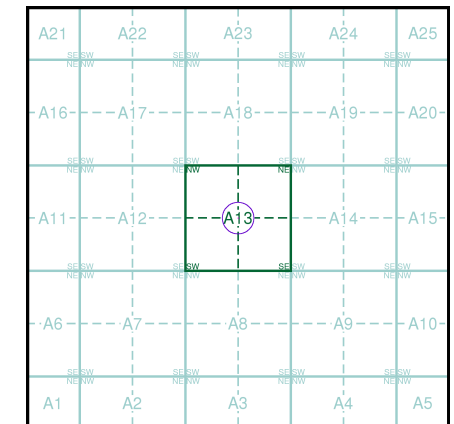

### Order Details

Order Number: 159449760\_1\_1  
 Customer Ref: 555065, 179077  
 National Grid Reference: 555060, 179080  
 Slice: A  
 Site Area (Ha): 0.01  
 Search Buffer (m): 1000

### Site Details

555065, 179077



Tel: 0844 844 9952  
 Fax: 0844 844 9951  
 Web: www.envirocheck.co.uk



© Crown copyright. All Rights Reserved. Licence Number 100022432.



**10k Raster Mapping**  
**Published 1999**  
**Source map scale - 1:10,000**

The historical maps shown were produced from the Ordnance Survey's 1:10,000 colour raster mapping. These maps are derived from Landplan which replaced the old 1:10,000 maps originally published in 1970. The data is highly detailed showing buildings, fences and field boundaries as well as all roads, tracks and paths. Road names are also included together with the relevant road number and classification. Boundary information depiction includes county, unitary authority, district, civil parish and constituency.

**Map Name(s) and Date(s)**

TQ58SW	TQ58SE
1999	1999
1:10,000	1:10,000
TQ57NW	TQ57NE
1999	1999
1:10,000	1:10,000

**Historical Map - Slice A**

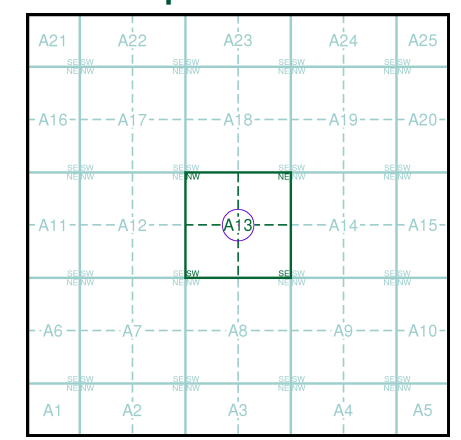

**Order Details**

Order Number: 159449760\_1\_1  
 Customer Ref: 555065, 179077  
 National Grid Reference: 555060, 179080  
 Slice: A  
 Site Area (Ha): 0.01  
 Search Buffer (m): 1000

**Site Details**

555065, 179077



Tel: 0844 844 9952  
 Fax: 0844 844 9951  
 Web: www.envirocheck.co.uk

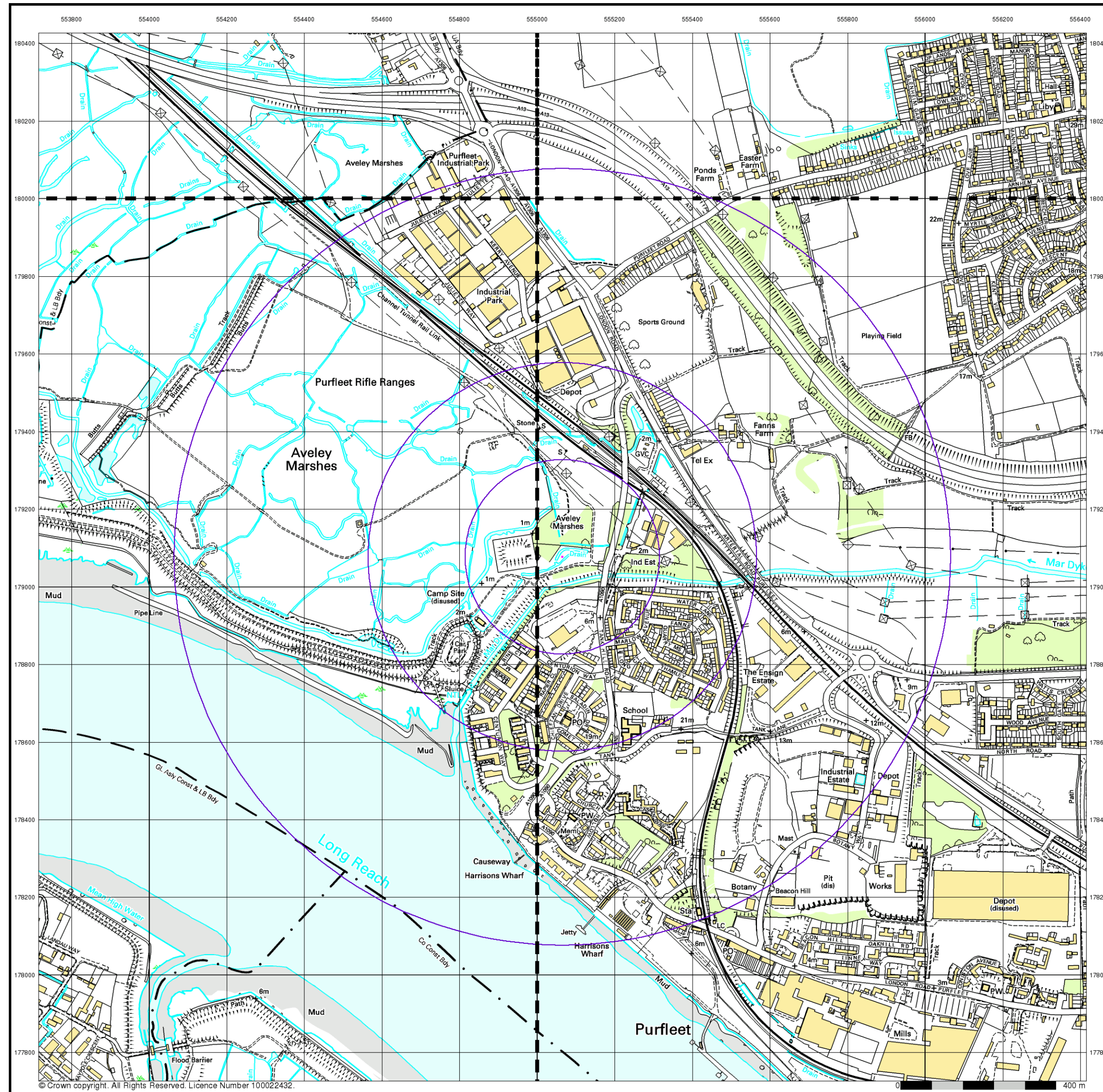

### 10k Raster Mapping

Published 2006

Source map scale - 1:10,000

The historical maps shown were produced from the Ordnance Survey's 1:10,000 colour raster mapping. These maps are derived from Landplan which replaced the old 1:10,000 maps originally published in 1970. The data is highly detailed showing buildings, fences and field boundaries as well as all roads, tracks and paths. Road names are also included together with the relevant road number and classification. Boundary information depiction includes county, unitary authority, district, civil parish and constituency.

### Map Name(s) and Date(s)

TQ58SW 2006 1:10,000	TQ58SE 2006 1:10,000
TQ57NW 2006 1:10,000	TQ57NE 2006 1:10,000

### Historical Map - Slice A

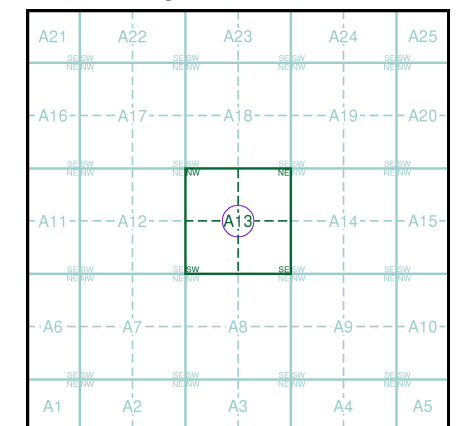

### Order Details

Order Number: 159449760\_1\_1  
 Customer Ref: 555065, 179077  
 National Grid Reference: 555060, 179080  
 Slice: A  
 Site Area (Ha): 0.01  
 Search Buffer (m): 1000

### Site Details

555065, 179077



Tel: 0844 844 9952  
 Fax: 0844 844 9951  
 Web: www.envirocheck.co.uk

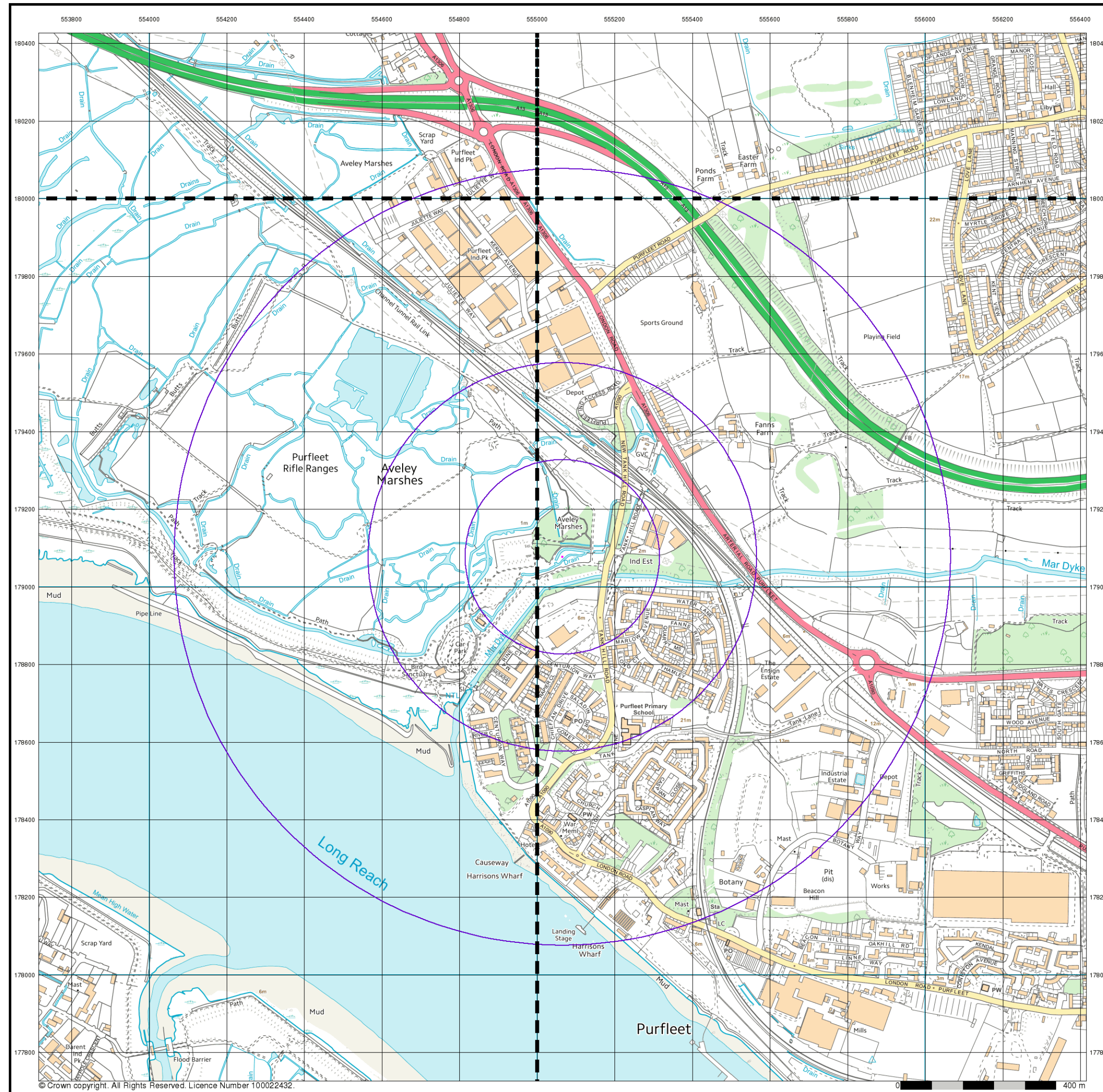

**VectorMap Local**

Published 2018

Source map scale - 1:10,000

VectorMap Local (Raster) is Ordnance Survey's highest detailed 'backdrop' mapping product. These maps are produced from OS's VectorMap Local, a simple vector dataset at a nominal scale of 1:10,000, covering the whole of Great Britain, that has been designed for creating graphical mapping. OS VectorMap Local is derived from large-scale information surveyed at 1:1250 scale (covering major towns and cities), 1:2500 scale (smaller towns, villages and developed rural areas), and 1:10 000 scale (mountain, moorland and river estuary areas).

**Map Name(s) and Date(s)**

TQ58SW 2018 Variable	TQ58SE 2018 Variable
TQ57NW 2018 Variable	TQ57NE 2018 Variable

**Historical Map - Slice A**

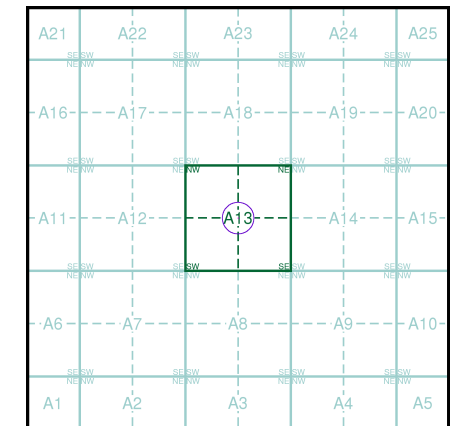

**Order Details**

Order Number: 159449760\_1\_1  
 Customer Ref: 555065, 179077  
 National Grid Reference: 555060, 179080  
 Slice: A  
 Site Area (Ha): 0.01  
 Search Buffer (m): 1000

**Site Details**

555065, 179077



Tel: 0844 844 9952  
 Fax: 0844 844 9951  
 Web: www.envirocheck.co.uk

# Historical Mapping Legends

## Ordnance Survey County Series 1:10,560

- Gravel Pit
- Sand Pit
- Other Pits
- Quarry
- Shingle
- Orchard
- Osiers
- Reeds
- Marsh
- Mixed Wood
- Deciduous
- Brushwood
- Fir
- Furze
- Rough Pasture
- Arrow denotes flow of water
- Trigonometrical Station
- Site of Antiquities
- Bench Mark
- Pump, Guide Post, Signal Post
- Well, Spring, Boundary Post
- 285** Surface Level
- Sketched Contour
- Instrumental Contour
- Main Roads
- Minor Roads
- Sunken Road
- Raised Road
- Road over Railway
- Railway over River
- Railway over Road
- Level Crossing
- Road over River or Canal
- Road over Stream
- Road over Stream
- County Boundary (Geographical)
- County & Civil Parish Boundary
- Administrative County & Civil Parish Boundary
- County Borough Boundary (England)
- County Burgh Boundary (Scotland)
- Rural District Boundary
- Civil Parish Boundary

## Ordnance Survey Plan 1:10,000

- Chalk Pit, Clay Pit or Quarry
- Gravel Pit
- Sand Pit
- Disused Pit or Quarry
- Refuse or Slag Heap
- Lake, Loch or Pond
- Dunes
- Boulders
- Coniferous Trees
- Non-Coniferous Trees
- Orchard
- Scrub
- Coppice
- Bracken
- Heath
- Rough Grassland
- Marsh
- Reeds
- Saltings
- Building
- Glasshouse
- Sloping Masonry
- Pylon
- Electricity Transmission Line
- Pole
- Cutting
- Embankment
- Standard Gauge Multiple Track
- Standard Gauge Single Track
- Siding, Tramway or Mineral Line
- Narrow Gauge
- Geographical County
- Administrative County, County Borough or County of City
- Municipal Borough, Urban or Rural District, Burgh or District Council
- Borough, Burgh or County Constituency  
Shown only when not coincident with other boundaries
- Civil Parish  
Shown alternately when coincidence of boundaries occurs
- BP, BS Boundary Post or Stone
- Ch Church
- CH Club House
- F E Sta Fire Engine Station
- FB Foot Bridge
- Fn Fountain
- GP Guide Post
- MP Mile Post
- MS Mile Stone
- Pol Sta Police Station
- PO Post Office
- PC Public Convenience
- PH Public House
- SB Signal Box
- Spr Spring
- TCB Telephone Call Box
- TCP Telephone Call Post
- W Well

## 1:10,000 Raster Mapping

- Gravel Pit
- Rock
- Boulders
- Shingle
- Sand
- Slopes
- General detail
- Overhead detail
- Multi-track railway
- County boundary (England only)
- District, Unitary, Metropolitan, London Borough boundary
- Area of wooded vegetation
- Non-coniferous trees (scattered)
- Coniferous trees (scattered)
- Orchard
- Rough Grassland
- Scrub
- Water feature
- MHW(S) Mean high water (springs)
- Telephone line (where shown)
- Bench mark (where shown)
- Point feature (e.g. Guide Post or Mile Stone)
- Site of (antiquity)
- General Building
- Refuse tip or slag heap
- Rock (scattered)
- Boulders (scattered)
- Mud
- Sand Pit
- Top of cliff
- Underground detail
- Narrow gauge railway
- Single track railway
- Civil, parish or community boundary
- Constituency boundary
- Non-coniferous trees
- Coniferous trees
- Positioned tree
- Coppice or Osiers
- Heath
- Marsh, Salt Marsh or Reeds
- Flow arrows
- MLW(S) Mean low water (springs)
- Electricity transmission line (with poles)
- Triangulation station
- Pylon, flare stack or lighting tower
- Glasshouse
- Important Building



## Historical Mapping & Photography included:

Mapping Type	Scale	Date	Pg
Kent	1:10,560	1869	3
Essex	1:10,560	1872 - 1873	4
Kent	1:10,560	1898	5
Essex	1:10,560	1898 - 1899	6
Kent	1:10,560	1910	7
London	1:10,560	1920	8
Essex	1:10,560	1921	9
Kent	1:10,560	1931	10
Kent	1:10,560	1938	11
London	1:10,560	1938	12
Essex	1:10,560	1938	13
Kent	1:10,560	1939 - 1951	14
Historical Aerial Photography	1:10,560	1947 - 1948	15
Historical Aerial Photography	1:10,560	1947	16
Ordnance Survey Plan	1:10,000	1961	17
Ordnance Survey Plan	1:10,000	1966 - 1967	18
Ordnance Survey Plan	1:10,000	1974 - 1977	19
Gravesend	1:10,000	1977	20
Ordnance Survey Plan	1:10,000	1983 - 1987	21
London	1:25,000	1985	22
Ordnance Survey Plan	1:10,000	1988	23
Ordnance Survey Plan	1:10,000	1992 - 1996	24
Ordnance Survey Plan	1:10,000	1996	25
10K Raster Mapping	1:10,000	1999	26
10K Raster Mapping	1:10,000	2006	27
VectorMap Local	1:10,000	2018	28

## Historical Map - Slice A

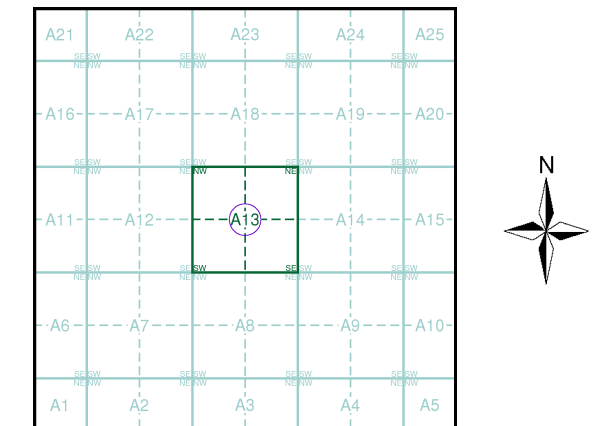

## Order Details

Order Number: 159450375\_1\_1  
 Customer Ref: 555085, 175676  
 National Grid Reference: 555080, 175680  
 Slice: A  
 Site Area (Ha): 0.01  
 Search Buffer (m): 1000

## Site Details

555085, 175676



Tel: 0844 844 9952  
 Fax: 0844 844 9951  
 Web: www.envirocheck.co.uk

# Russian Military Mapping Legends

## 1:5,000 and 1:10,000 mapping

a. Not drawn to scale b. Drawn to scale

	Government and Administrative Buildings		Military and Industrial Buildings
	Military and Communication Areas		Subway Entrance
	Fireproof Building		Prominent Fireproof Building
	Non-fireproof Building		Non-fireproof Building (non-dwelling)
	Factory, mill, and flour mill, with chimneys		Factory, mill, and flour mill, without chimneys
	Power Station, drawn to scale		Hydroelectric Power Station
	Radio Station, drawn to scale		Telephone Station, drawn to scale
	Abandoned Open-pit Mine or Quarry		Open-pit Salt Mine
	Pit		Oil Deposit or Well
	Oil Seepage		Natural Gas Tank
	Tailings Pile		Fuel Storage Tanks
	Bench Mark		Drill Hole
	Burial Mound		Triangulation Point on Burial Mound
	Single-track Railroad		Double-track Railroad
	Small Bridge		Tunnel
	Pipe (Culvert)		Railroad and Station Building
	Coniferous Forest		Deciduous Forest
	Mixed Forest		Lawns
	Citrus Orchard		Wet Ground
	Scattered Vegetation		

**243,8** Values for prominent elevations  
**186.0** Numbers for spot elevations, depth soundings, contour lines, etc.  
**0,2** Velocity of the current, width of river bed, depth of river  
**180/12** Fractional terms: length and capacity of bridges; depth of fords and condition of the river bottom; height of forest and the diameter of trees

### Russian Alphabet (For reference and phonetic interpretation of map text)

<b>А а (A)</b>	<b>З з (Z)</b>	<b>П п (P)</b>	<b>Ч ч (CH)</b>
<b>Б б (B)</b>	<b>И и (I)</b>	<b>Р р (R)</b>	<b>Ш ш (SH)</b>
<b>В в (V)</b>	<b>Й й (Y)</b>	<b>С с (S)</b>	<b>Щ щ (SHCH)</b>
<b>Г г (G)</b>	<b>К к (K)</b>	<b>Т т (T)</b>	<b>Ъ (-)</b>
<b>Д д (D)</b>	<b>Л л (L)</b>	<b>У у (U)</b>	<b>Ы (Y)</b>
<b>Е е (E)</b>	<b>М м (M)</b>	<b>Ф ф (F)</b>	<b>Ь (')</b>
<b>Ё ё (YO)</b>	<b>Н н (N)</b>	<b>Х х (KH)</b>	<b>Э э (E)</b>
<b>Ж ж (ZH)</b>	<b>О о (O)</b>	<b>Ц ц (TS)</b>	<b>Ю ю (YU or IU)</b>
			<b>Я я (YA or IA)</b>

## 1:25,000 mapping

a. Not drawn to scale b. Drawn to scale

	Government and Administrative Buildings		Military and Industrial Buildings
	Military and Communication Areas		Subway Entrance
	Partly Demolished Buildings		Demolished Buildings
	Built-Up Area with Fireproof Buildings Predominant		Built-Up Area with Non-Fireproof Buildings Predominant
	Individual Fireproof Building		Prominent Industrial Building
	Individual Dwelling, Fireproof		Ruins of an Individual Dwelling
	Factory or Mill Chimney		Factory or Mill with Chimney
	Factory or Mill without Chimney		Salt Mine
	Operating Shaft or Mine		Non-Operating Shaft or Mine
	Tailings Pile		Gas Pump or Service Station
	Fuel Storage or Natural Gas Tank		Oil or Natural Gas Derrick
	Small Hydroelectric Power Station		Power Station
	Transformer Station		Cemetery
	Burial Mound (height in metres)		Triangulation Point on Burial Mound
	Triangulation Point		Bench Mark
	Bench Mark (monumented)		Telegraph Office
	Telephone Station		Radio Station
	Radio Tower		Airfield or Seaplane Base
	Landing Strip		Cut
	Fill		Km Post
	Plantings		Width of Road
	Steep Grade		Highway under Construction
	Improved Dirt Road (former truck road)		Small Bridge
	Pipe (Culvert)		Tunnel
	Dismantled Railroad		Double-track Railroad with First Class Station
	Railroad Under Construction		Shore Embankment
	River or Ditch with Embankment		Water Gauge
	Direction and velocity of current		Water Level Mark
	Well		Spring
	Water Reservoir or Rain Water Pit		Isobath with value
	Heavy (Index) Contour Line		Half Contour Line
	Contour Line and Value		Spot Elevation Value
	Coniferous		Deciduous
	Mixed		Scrub

## Key to Numbers on Mapping



### Historical Mapping & Photography included:

Mapping Type	Scale	Date	Pg
Kent	1:10,560	1869	3
Essex	1:10,560	1872 - 1873	4
Kent	1:10,560	1898	5
Essex	1:10,560	1898 - 1899	6
Kent	1:10,560	1910	7
London	1:10,560	1920	8
Essex	1:10,560	1921	9
Kent	1:10,560	1931	10
Kent	1:10,560	1938	11
London	1:10,560	1938	12
Essex	1:10,560	1938	13
Kent	1:10,560	1939 - 1951	14
Historical Aerial Photography	1:10,560	1947 - 1948	15
Historical Aerial Photography	1:10,560	1947	16
Ordnance Survey Plan	1:10,000	1961	17
Ordnance Survey Plan	1:10,000	1966 - 1967	18
Ordnance Survey Plan	1:10,000	1974 - 1977	19
Gravesend	1:10,000	1977	20
Ordnance Survey Plan	1:10,000	1983 - 1987	21
London	1:25,000	1985	22
Ordnance Survey Plan	1:10,000	1988	23
Ordnance Survey Plan	1:10,000	1992 - 1996	24
Ordnance Survey Plan	1:10,000	1996	25
10K Raster Mapping	1:10,000	1999	26
10K Raster Mapping	1:10,000	2006	27
VectorMap Local	1:10,000	2018	28

### Russian Map - Slice A

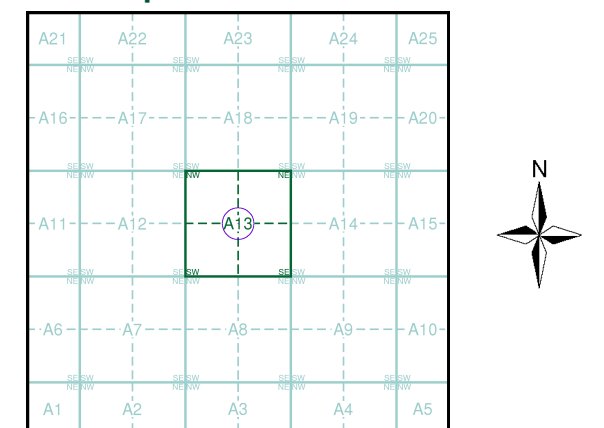

### Order Details

Order Number: 159450375\_1\_1  
 Customer Ref: 555085, 175676  
 National Grid Reference: 555080, 175680  
 Slice: A  
 Site Area (Ha): 0.01  
 Search Buffer (m): 1000

### Site Details

555085, 175676

**Landmark**  
 INFORMATION GROUP

Tel: 0844 844 9952  
 Fax: 0844 844 9951  
 Web: www.envirocheck.co.uk

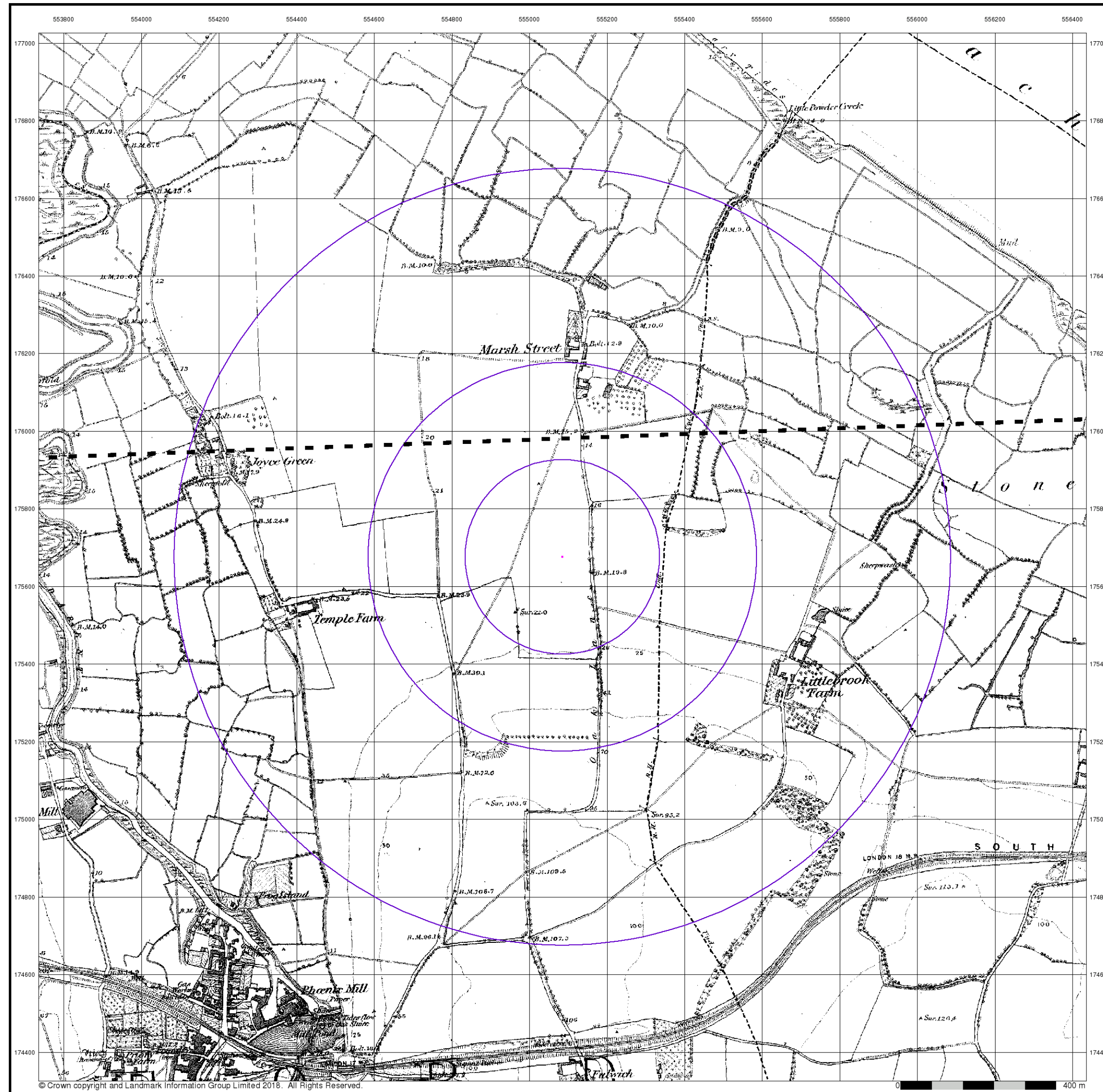

**Kent**

**Published 1869**

**Source map scale - 1:10,560**

The historical maps shown were reproduced from maps predominantly held at the scale adopted for England, Wales and Scotland in the 1840's. In 1854 the 1:2,500 scale was adopted for mapping urban areas; these maps were used to update the 1:10,560 maps. The published date given therefore is often some years later than the surveyed date. Before 1938, all OS maps were based on the Cassini Projection, with independent surveys of a single county or group of counties, giving rise to significant inaccuracies in outlying areas. In the late 1940's, a Provisional Edition was produced, which updated the 1:10,560 mapping from a number of sources. The maps appear unfinished - with all military camps and other strategic sites removed. These maps were initially overprinted with the National Grid. In 1970, the first 1:10,000 maps were produced using the Transverse Mercator Projection. The revision process continued until recently, with new editions appearing every 10 years or so for urban areas.

**Map Name(s) and Date(s)**

00300	1869	1:10,560
00900	1869	1:10,560

**Historical Map - Slice A**

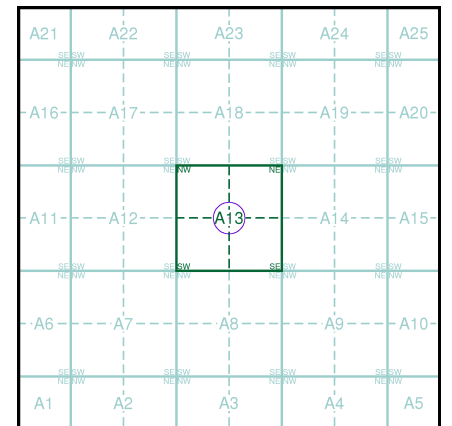

**Order Details**

Order Number: 159450375\_1\_1  
 Customer Ref: 555085, 175676  
 National Grid Reference: 555080, 175680  
 Slice: A  
 Site Area (Ha): 0.01  
 Search Buffer (m): 1000

**Site Details**

555085, 175676



Tel: 0844 844 9952  
 Fax: 0844 844 9951  
 Web: www.envirocheck.co.uk



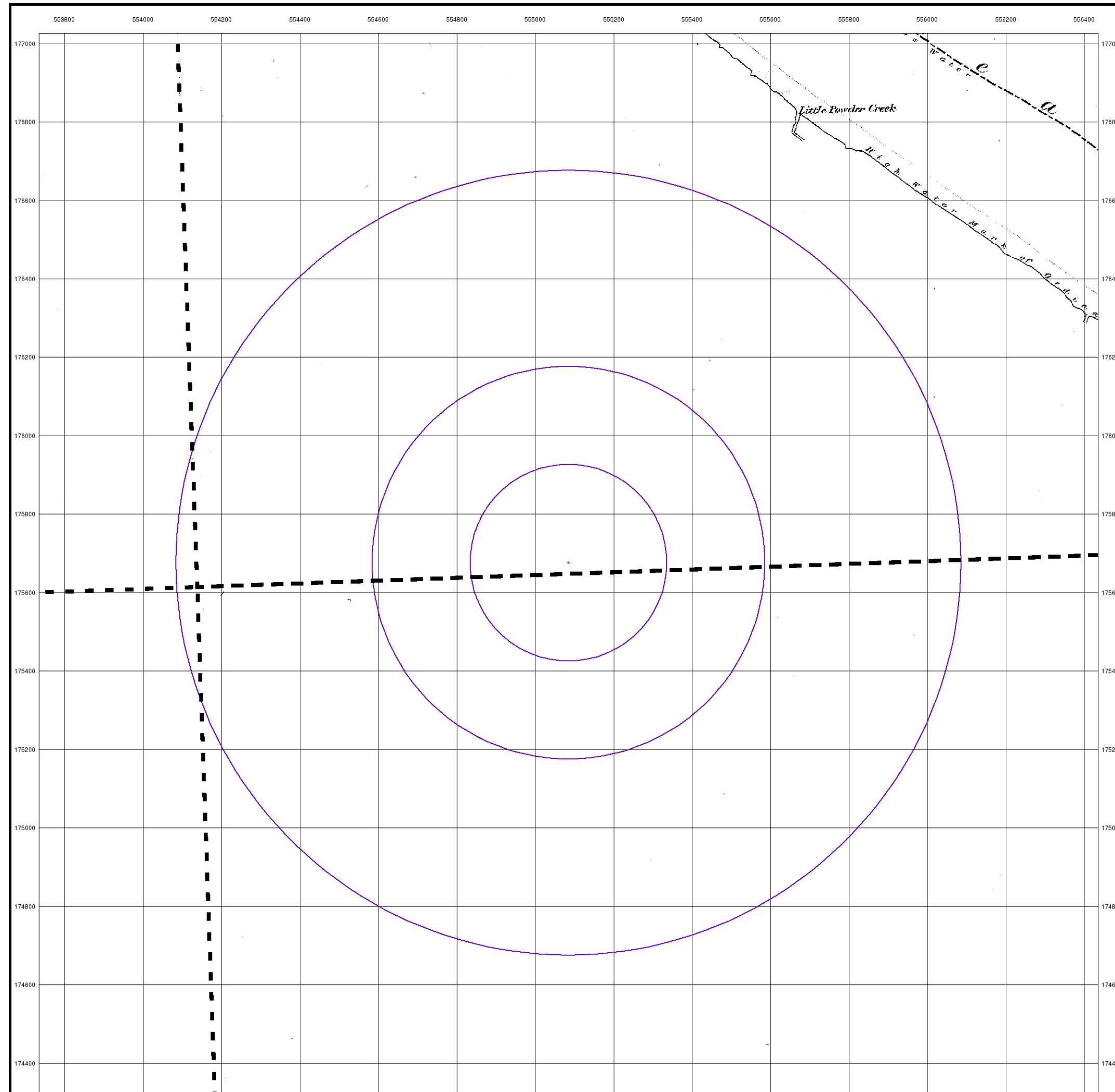

Essex

Published 1872 - 1873

Source map scale - 1:10,560

The historical maps shown were reproduced from maps predominantly held at the scale adopted for England, Wales and Scotland in the 1840's. In 1854 the 1:2,500 scale was adopted for mapping urban areas; these maps were used to update the 1:10,560 maps. The published date given therefore is often some years later than the surveyed date. Before 1938, all OS maps were based on the Cassini Projection, with independent surveys of a single county or group of counties, giving rise to significant inaccuracies in outlying areas. In the late 1940's, a Provisional Edition was produced, which updated the 1:10,560 mapping from a number of sources. The maps appear unfinished - with all military camps and other strategic sites removed. These maps were initially overprinted with the National Grid. In 1970, the first 1:10,000 maps were produced using the Transverse Mercator Projection. The revision process continued until recently, with new editions appearing every 10 years or so for urban areas.

Map Name(s) and Date(s)

08200 1873 1:10,560	08300 1873 1:10,560
	08800 1872 1:10,560

Historical Map - Slice A

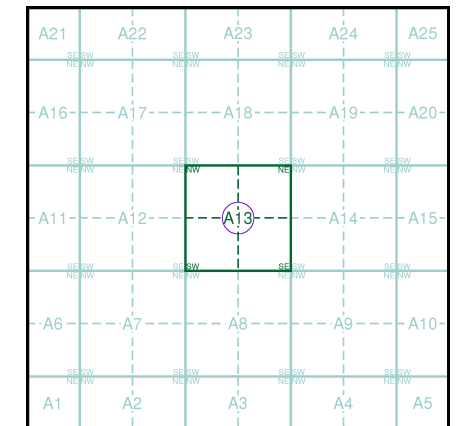

Order Details

Order Number: 159450375\_1\_1  
 Customer Ref: 555085, 175676  
 National Grid Reference: 555080, 175680  
 Slice: A  
 Site Area (Ha): 0.01  
 Search Buffer (m): 1000

Site Details

555085, 175676



Tel: 0844 844 9952  
 Fax: 0844 844 9951  
 Web: www.envirocheck.co.uk

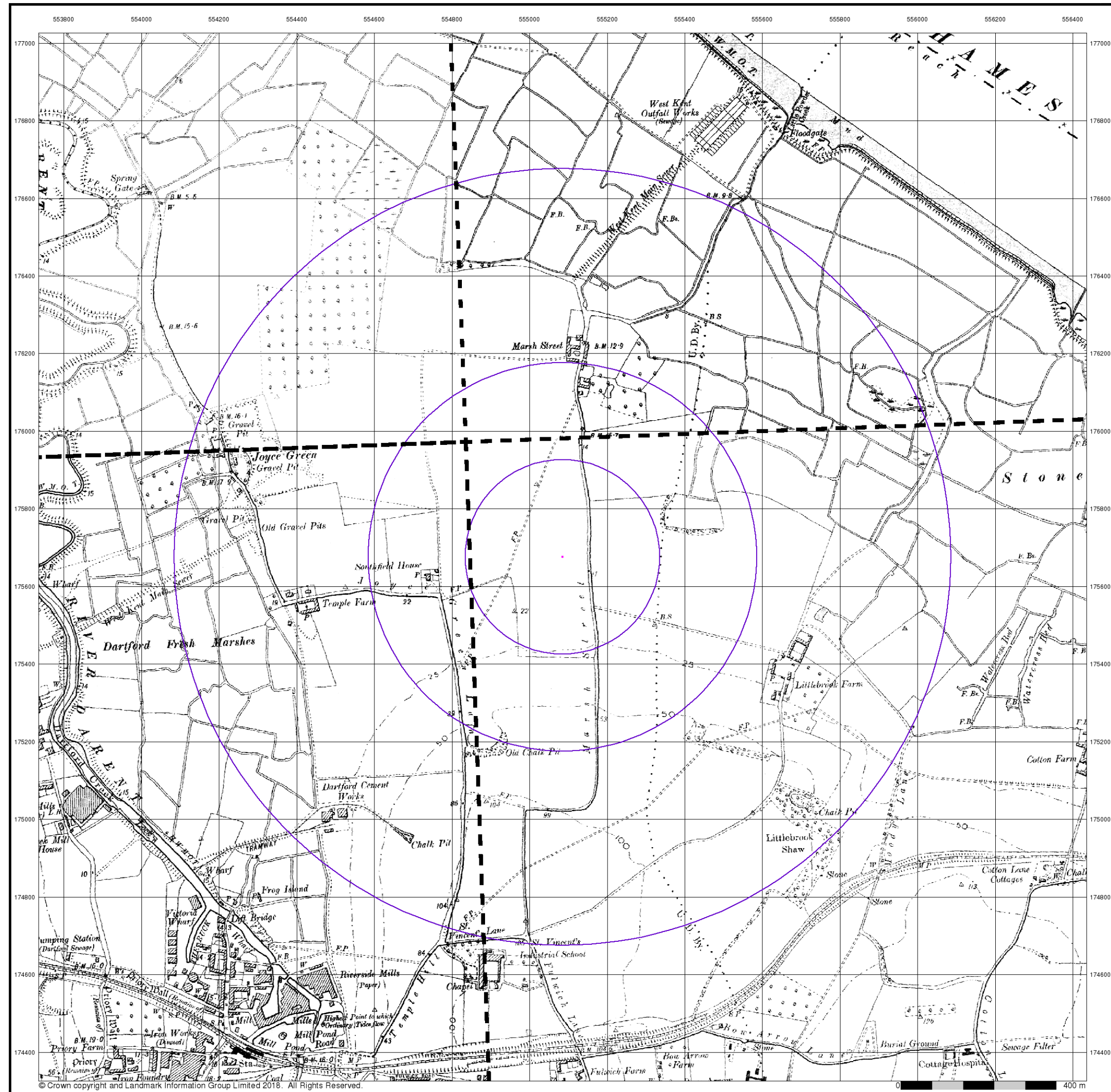

**Kent**

**Published 1898**

**Source map scale - 1:10,560**

The historical maps shown were reproduced from maps predominantly held at the scale adopted for England, Wales and Scotland in the 1840's. In 1854 the 1:2,500 scale was adopted for mapping urban areas; these maps were used to update the 1:10,560 maps. The published date given therefore is often some years later than the surveyed date. Before 1938, all OS maps were based on the Cassini Projection, with independent surveys of a single county or group of counties, giving rise to significant inaccuracies in outlying areas. In the late 1940's, a Provisional Edition was produced, which updated the 1:10,560 mapping from a number of sources. The maps appear unfinished - with all military camps and other strategic sites removed. These maps were initially overprinted with the National Grid. In 1970, the first 1:10,000 maps were produced using the Transverse Mercator Projection. The revision process continued until recently, with new editions appearing every 10 years or so for urban areas.

**Map Name(s) and Date(s)**

003SW 1898 1:10,560	003SE 1898 1:10,560
009NW 1898 1:10,560	009NE 1898 1:10,560

**Historical Map - Slice A**

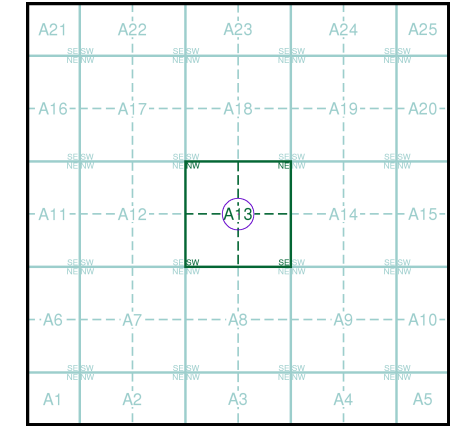

**Order Details**

Order Number: 159450375\_1\_1  
 Customer Ref: 555085, 175676  
 National Grid Reference: 555080, 175680  
 Slice: A  
 Site Area (Ha): 0.01  
 Search Buffer (m): 1000

**Site Details**

555085, 175676



Tel: 0844 844 9952  
 Fax: 0844 844 9951  
 Web: www.envirocheck.co.uk

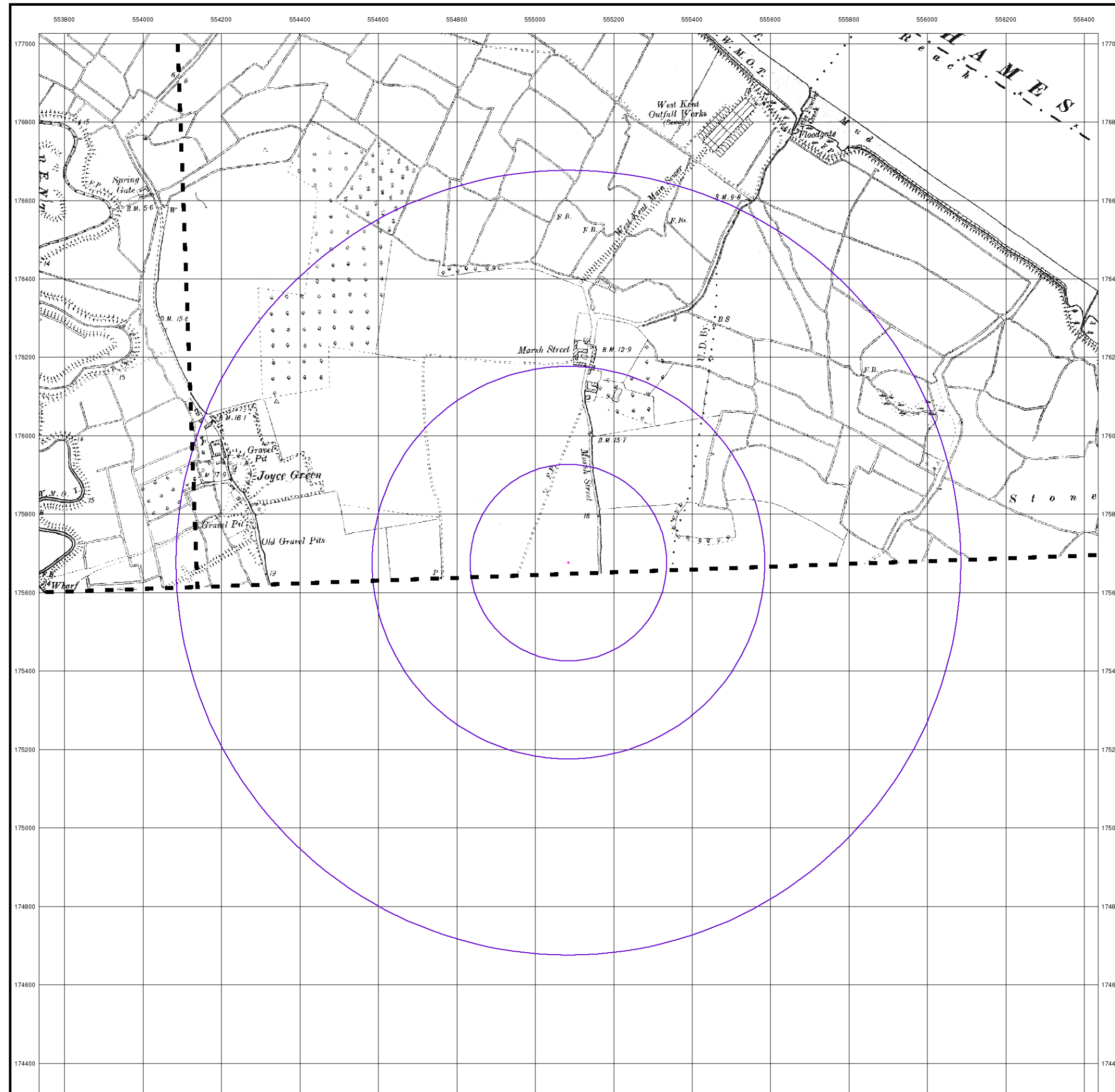

Essex

Published 1898 - 1899

Source map scale - 1:10,560

The historical maps shown were reproduced from maps predominantly held at the scale adopted for England, Wales and Scotland in the 1840's. In 1854 the 1:2,500 scale was adopted for mapping urban areas; these maps were used to update the 1:10,560 maps. The published date given therefore is often some years later than the surveyed date. Before 1938, all OS maps were based on the Cassini Projection, with independent surveys of a single county or group of counties, giving rise to significant inaccuracies in outlying areas. In the late 1940's, a Provisional Edition was produced, which updated the 1:10,560 mapping from a number of sources. The maps appear unfinished - with all military camps and other strategic sites removed. These maps were initially overprinted with the National Grid. In 1970, the first 1:10,000 maps were produced using the Transverse Mercator Projection. The revision process continued until recently, with new editions appearing every 10 years or so for urban areas.

Map Name(s) and Date(s)

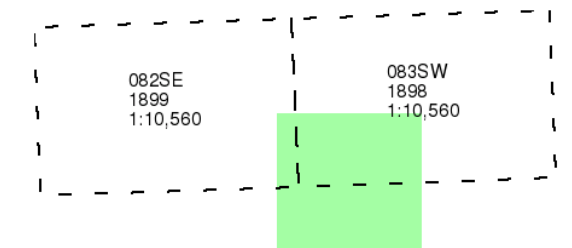

Historical Map - Slice A

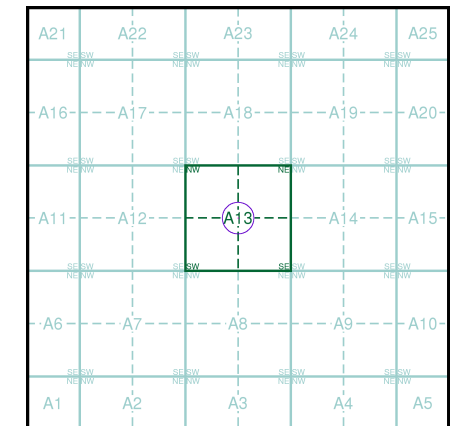

Order Details

Order Number: 159450375\_1\_1  
 Customer Ref: 555085, 175676  
 National Grid Reference: 555080, 175680  
 Slice: A  
 Site Area (Ha): 0.01  
 Search Buffer (m): 1000

Site Details

555085, 175676



Tel: 0844 844 9952  
 Fax: 0844 844 9951  
 Web: www.envirocheck.co.uk

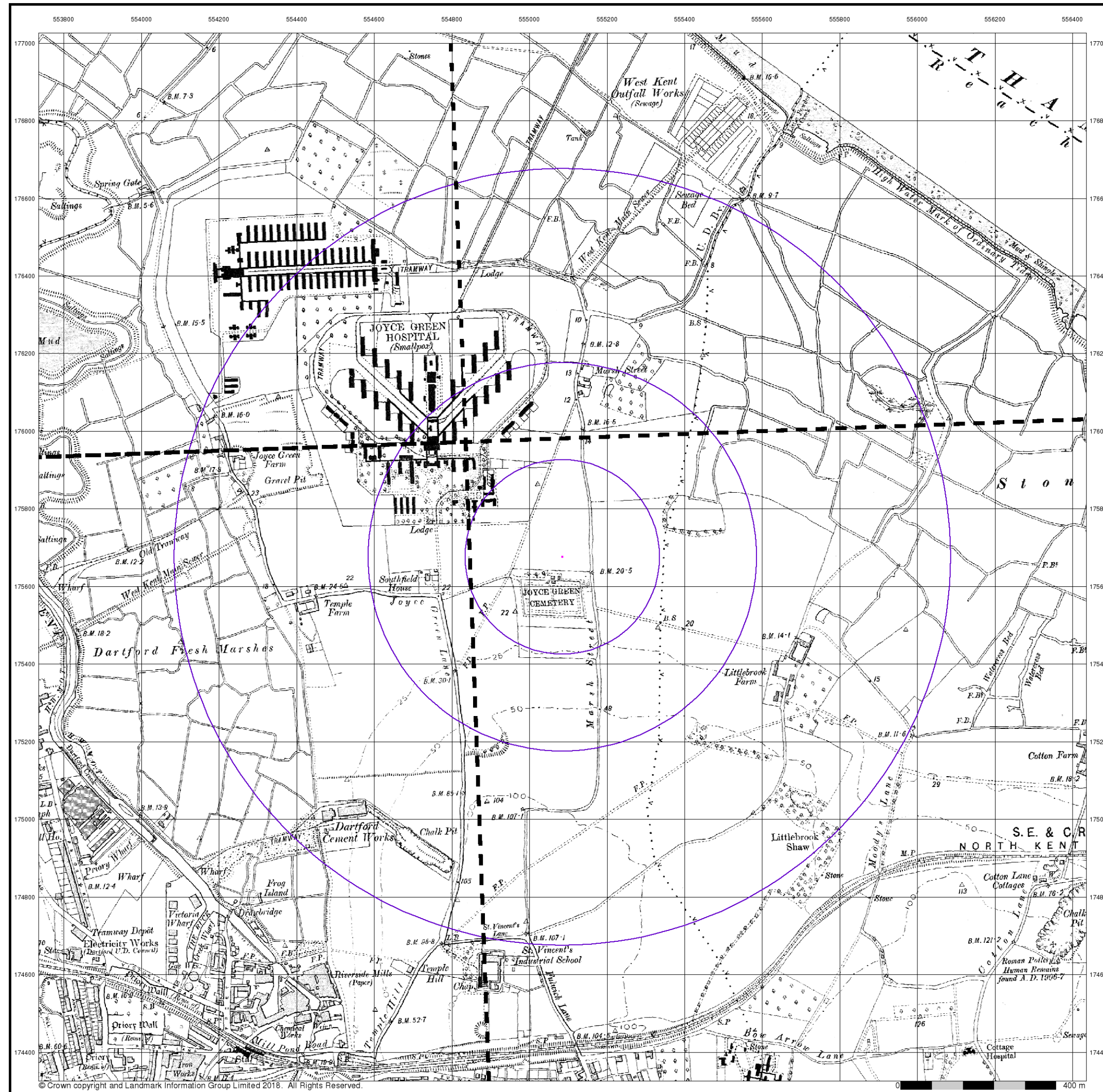

**Kent**

**Published 1910**

**Source map scale - 1:10,560**

The historical maps shown were reproduced from maps predominantly held at the scale adopted for England, Wales and Scotland in the 1840's. In 1854 the 1:2,500 scale was adopted for mapping urban areas; these maps were used to update the 1:10,560 maps. The published date given therefore is often some years later than the surveyed date. Before 1938, all OS maps were based on the Cassini Projection, with independent surveys of a single county or group of counties, giving rise to significant inaccuracies in outlying areas. In the late 1940's, a Provisional Edition was produced, which updated the 1:10,560 mapping from a number of sources. The maps appear unfinished - with all military camps and other strategic sites removed. These maps were initially overprinted with the National Grid. In 1970, the first 1:10,000 maps were produced using the Transverse Mercator Projection. The revision process continued until recently, with new editions appearing every 10 years or so for urban areas.

**Map Name(s) and Date(s)**

003SW 1910 1:10,560	003SE 1910 1:10,560
009NW 1910 1:10,560	009NE 1910 1:10,560

**Historical Map - Slice A**

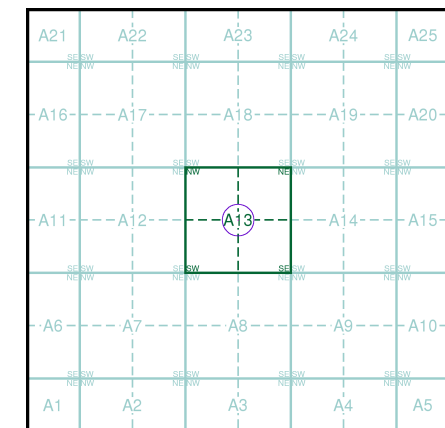

**Order Details**

Order Number: 159450375\_1\_1  
 Customer Ref: 555085, 175676  
 National Grid Reference: 555080, 175680  
 Slice: A  
 Site Area (Ha): 0.01  
 Search Buffer (m): 1000

**Site Details**

555085, 175676



Tel: 0844 844 9952  
 Fax: 0844 844 9951  
 Web: www.envirocheck.co.uk

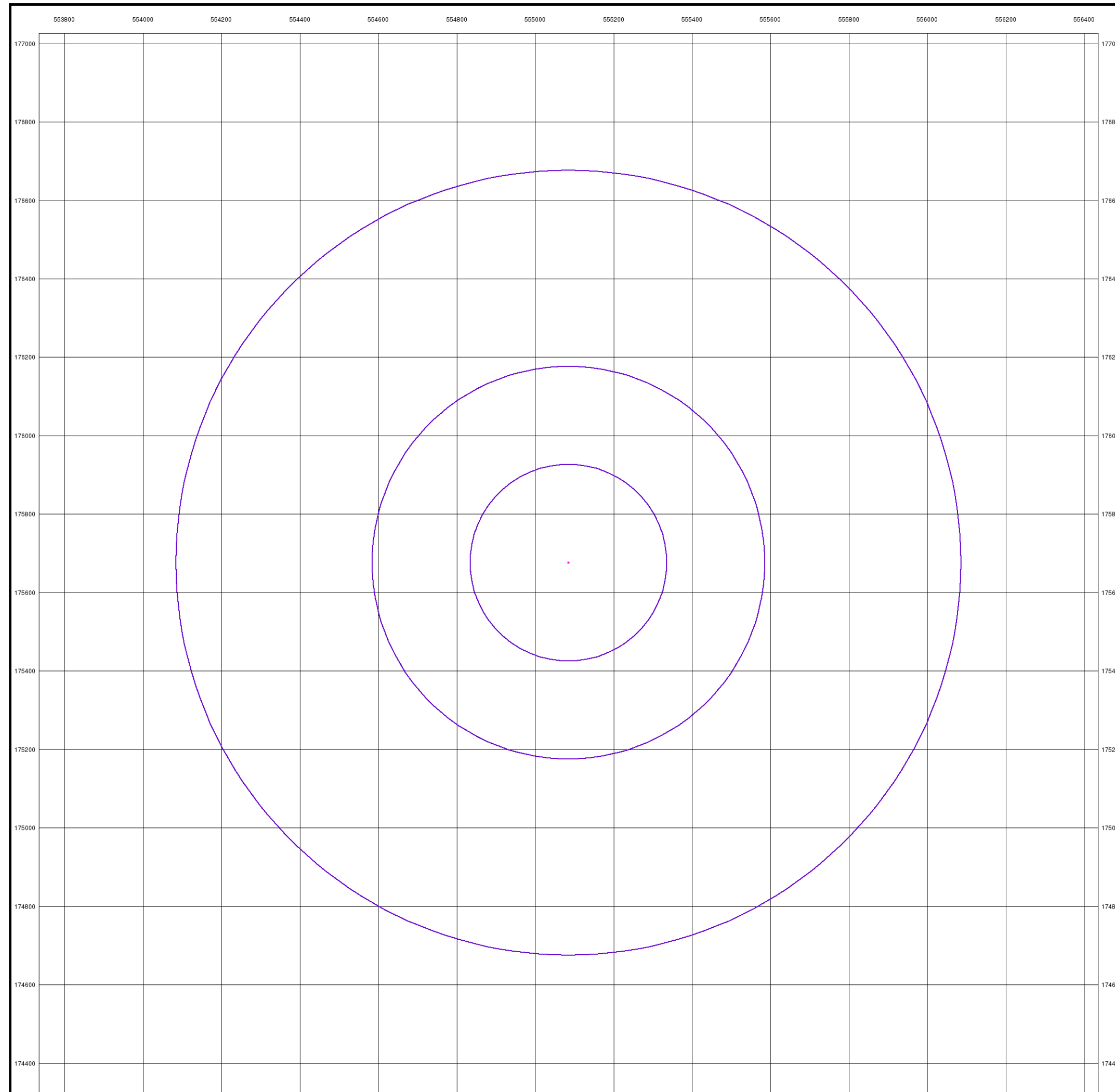

**London**

**Published 1920**

**Source map scale - 1:10,560**

The historical maps shown were reproduced from maps predominantly held at the scale adopted for England, Wales and Scotland in the 1840's. In 1854 the 1:2,500 scale was adopted for mapping urban areas; these maps were used to update the 1:10,560 maps. The published date given therefore is often some years later than the surveyed date. Before 1938, all OS maps were based on the Cassini Projection, with independent surveys of a single county or group of counties, giving rise to significant inaccuracies in outlying areas. In the late 1940's, a Provisional Edition was produced, which updated the 1:10,560 mapping from a number of sources. The maps appear unfinished - with all military camps and other strategic sites removed. These maps were initially overprinted with the National Grid. In 1970, the first 1:10,000 maps were produced using the Transverse Mercator Projection. The revision process continued until recently, with new editions appearing every 10 years or so for urban areas.

**Map Name(s) and Date(s)**

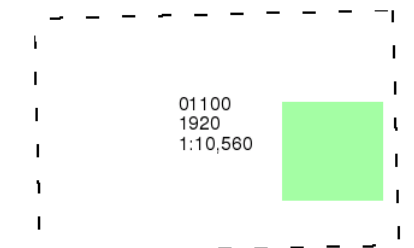

**Historical Map - Slice A**

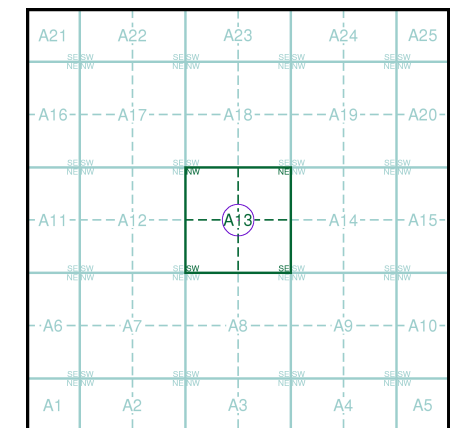

**Order Details**

Order Number: 159450375\_1\_1  
 Customer Ref: 555085, 175676  
 National Grid Reference: 555080, 175680  
 Slice: A  
 Site Area (Ha): 0.01  
 Search Buffer (m): 1000

**Site Details**

555085, 175676



Tel: 0844 844 9952  
 Fax: 0844 844 9951  
 Web: www.envirocheck.co.uk

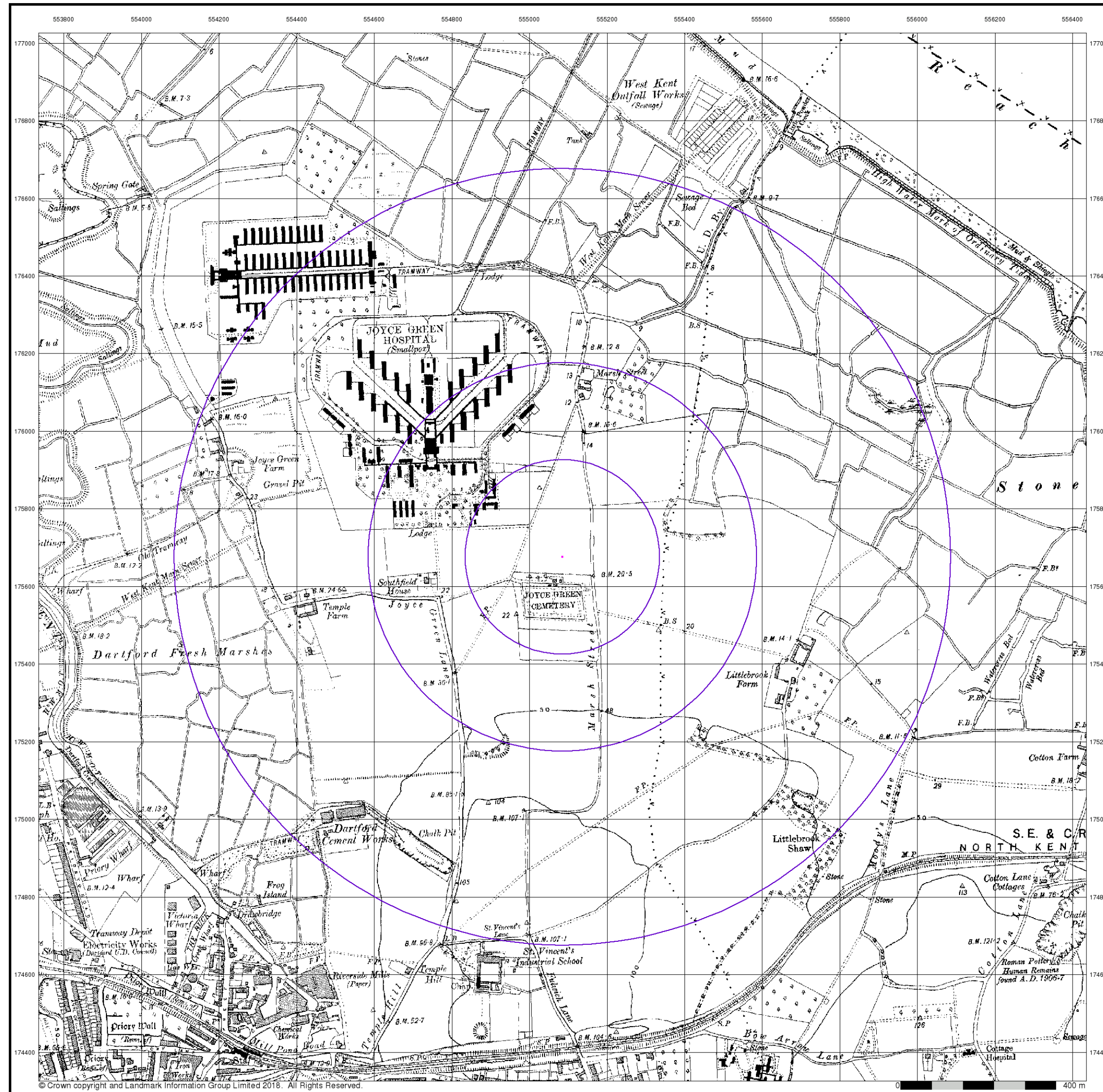

Essex

Published 1921

Source map scale - 1:10,560

The historical maps shown were reproduced from maps predominantly held at the scale adopted for England, Wales and Scotland in the 1840's. In 1854 the 1:2,500 scale was adopted for mapping urban areas; these maps were used to update the 1:10,560 maps. The published date given therefore is often some years later than the surveyed date. Before 1938, all OS maps were based on the Cassini Projection, with independent surveys of a single county or group of counties, giving rise to significant inaccuracies in outlying areas. In the late 1940's, a Provisional Edition was produced, which updated the 1:10,560 mapping from a number of sources. The maps appear unfinished - with all military camps and other strategic sites removed. These maps were initially overprinted with the National Grid. In 1970, the first 1:10,000 maps were produced using the Transverse Mercator Projection. The revision process continued until recently, with new editions appearing every 10 years or so for urban areas.

Map Name(s) and Date(s)

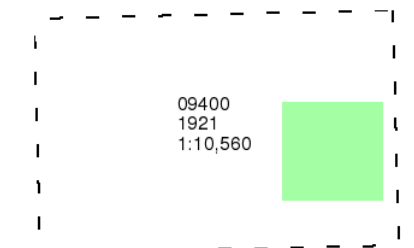

Historical Map - Slice A

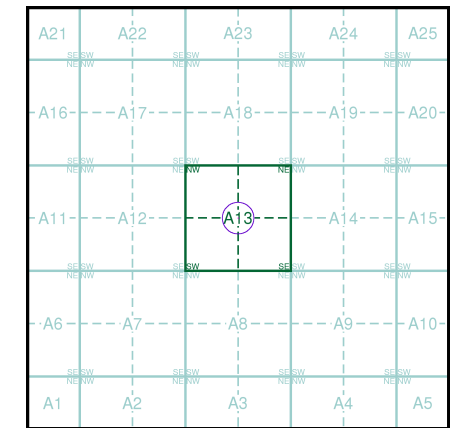

Order Details

Order Number: 159450375\_1\_1  
 Customer Ref: 555085, 175676  
 National Grid Reference: 555080, 175680  
 Slice: A  
 Site Area (Ha): 0.01  
 Search Buffer (m): 1000

Site Details

555085, 175676



Tel: 0844 844 9952  
 Fax: 0844 844 9951  
 Web: www.envirocheck.co.uk

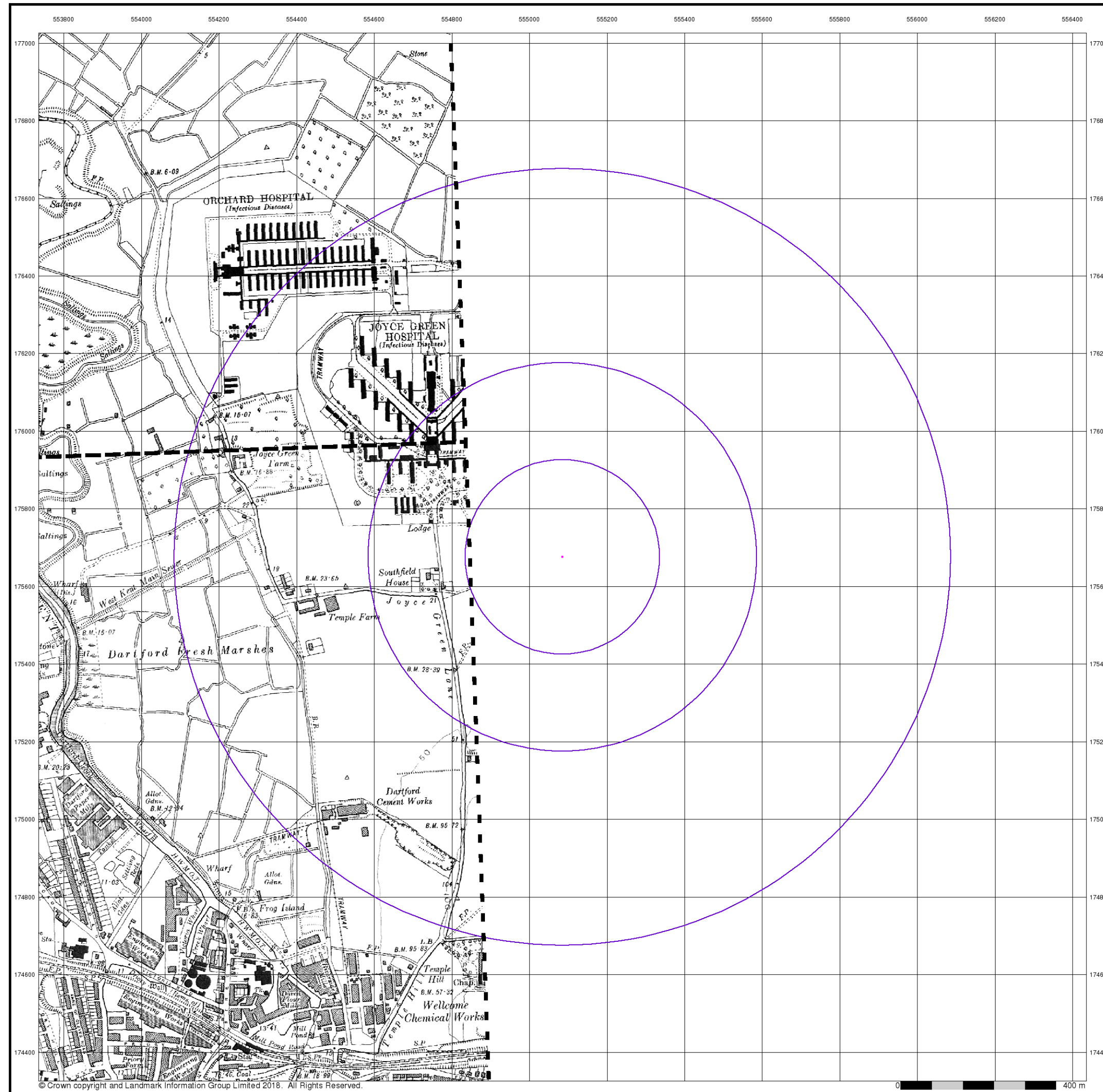

**Kent**

**Published 1931**

**Source map scale - 1:10,560**

The historical maps shown were reproduced from maps predominantly held at the scale adopted for England, Wales and Scotland in the 1840's. In 1854 the 1:2,500 scale was adopted for mapping urban areas; these maps were used to update the 1:10,560 maps. The published date given therefore is often some years later than the surveyed date. Before 1938, all OS maps were based on the Cassini Projection, with independent surveys of a single county or group of counties, giving rise to significant inaccuracies in outlying areas. In the late 1940's, a Provisional Edition was produced, which updated the 1:10,560 mapping from a number of sources. The maps appear unfinished - with all military camps and other strategic sites removed. These maps were initially overprinted with the National Grid. In 1970, the first 1:10,000 maps were produced using the Transverse Mercator Projection. The revision process continued until recently, with new editions appearing every 10 years or so for urban areas.

**Map Name(s) and Date(s)**

003SW	1931	1:10,560
009NW	1931	1:10,560

**Historical Map - Slice A**

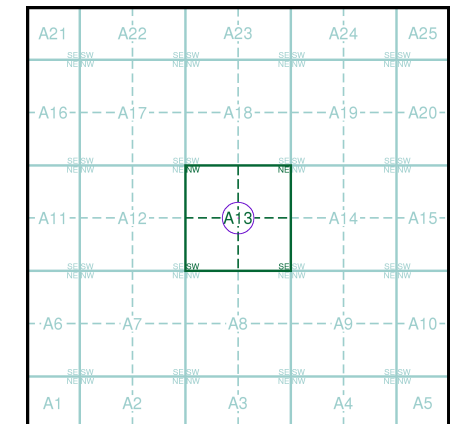

**Order Details**

Order Number: 159450375\_1\_1  
 Customer Ref: 555085, 175676  
 National Grid Reference: 555080, 175680  
 Slice: A  
 Site Area (Ha): 0.01  
 Search Buffer (m): 1000

**Site Details**

555085, 175676



Tel: 0844 844 9952  
 Fax: 0844 844 9951  
 Web: www.envirocheck.co.uk

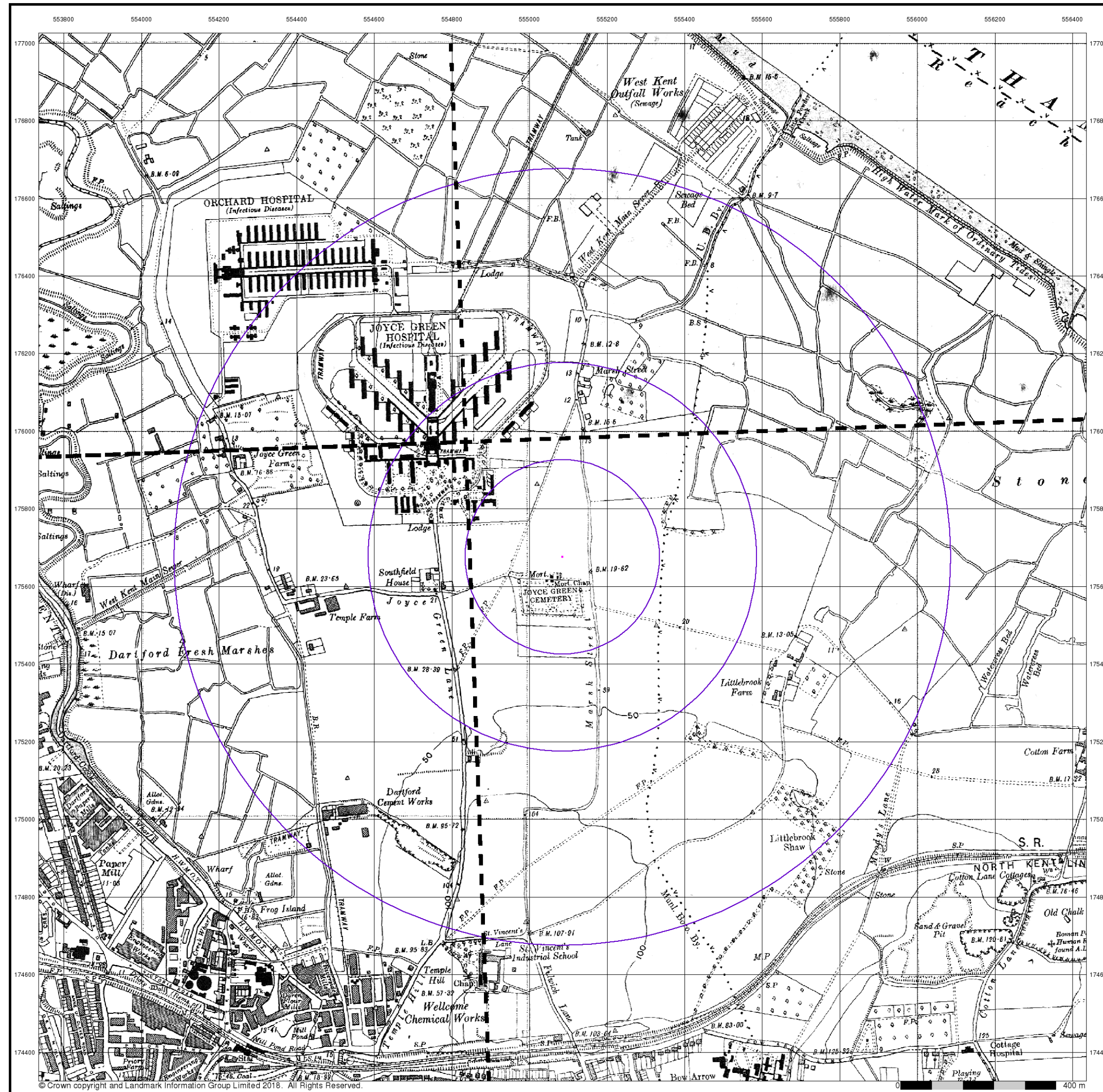

**Kent**

**Published 1938**

**Source map scale - 1:10,560**

The historical maps shown were reproduced from maps predominantly held at the scale adopted for England, Wales and Scotland in the 1840's. In 1854 the 1:2,500 scale was adopted for mapping urban areas; these maps were used to update the 1:10,560 maps. The published date given therefore is often some years later than the surveyed date. Before 1938, all OS maps were based on the Cassini Projection, with independent surveys of a single county or group of counties, giving rise to significant inaccuracies in outlying areas. In the late 1940's, a Provisional Edition was produced, which updated the 1:10,560 mapping from a number of sources. The maps appear unfinished - with all military camps and other strategic sites removed. These maps were initially overprinted with the National Grid. In 1970, the first 1:10,000 maps were produced using the Transverse Mercator Projection. The revision process continued until recently, with new editions appearing every 10 years or so for urban areas.

**Map Name(s) and Date(s)**

003SW 1938 1:10,560	003SE 1938 1:10,560
009NW 1938 1:10,560	009NE 1938 1:10,560

**Historical Map - Slice A**

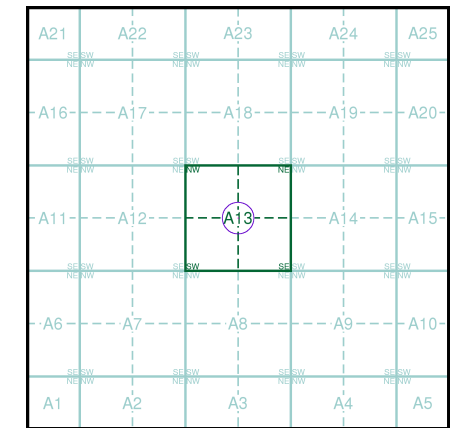

**Order Details**

Order Number: 159450375\_1\_1  
 Customer Ref: 555085, 175676  
 National Grid Reference: 555080, 175680  
 Slice: A  
 Site Area (Ha): 0.01  
 Search Buffer (m): 1000

**Site Details**

555085, 175676



Tel: 0844 844 9952  
 Fax: 0844 844 9951  
 Web: www.envirocheck.co.uk



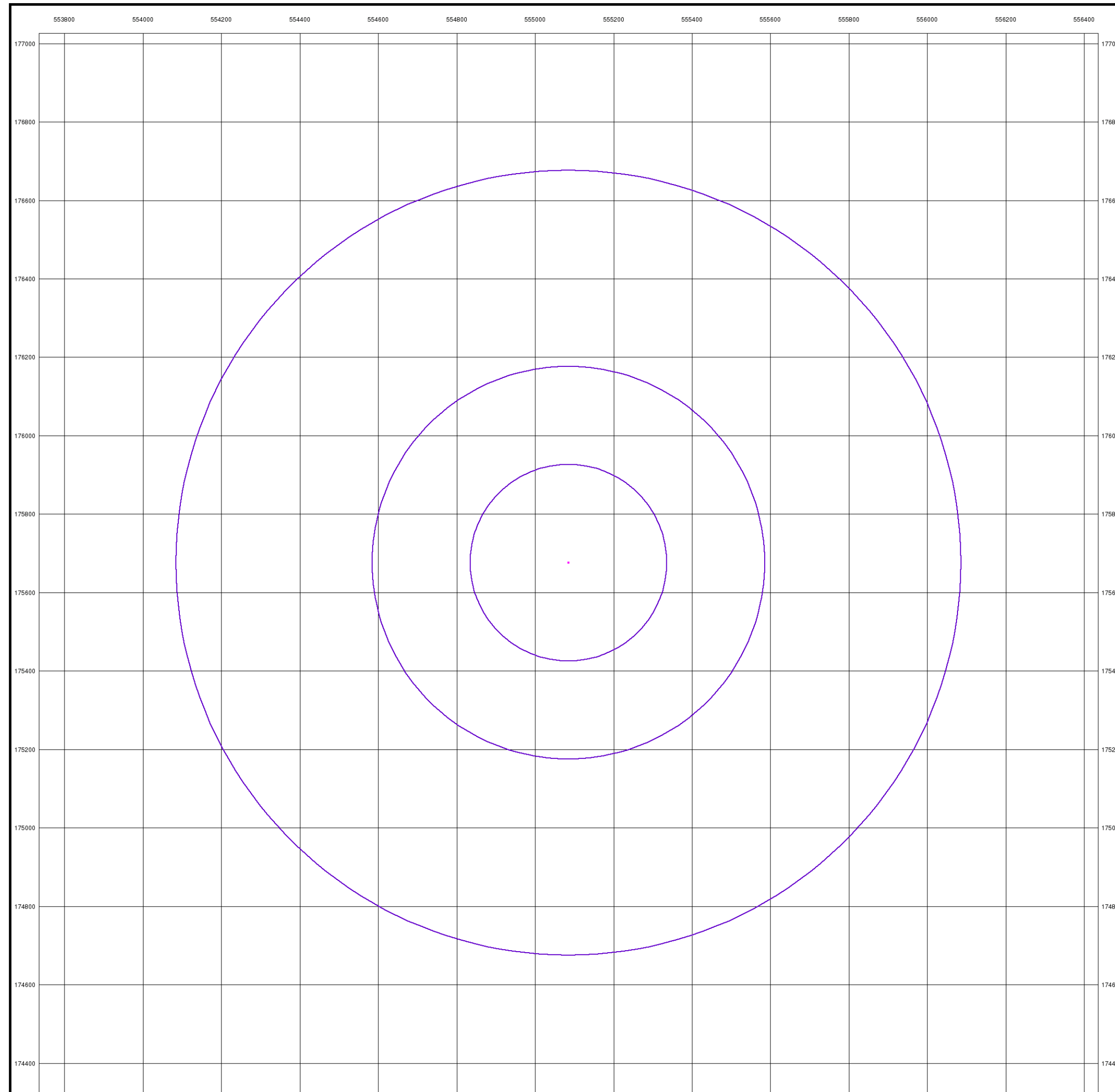

**London**

**Published 1938**

**Source map scale - 1:10,560**

The historical maps shown were reproduced from maps predominantly held at the scale adopted for England, Wales and Scotland in the 1840's. In 1854 the 1:2,500 scale was adopted for mapping urban areas; these maps were used to update the 1:10,560 maps. The published date given therefore is often some years later than the surveyed date. Before 1938, all OS maps were based on the Cassini Projection, with independent surveys of a single county or group of counties, giving rise to significant inaccuracies in outlying areas. In the late 1940's, a Provisional Edition was produced, which updated the 1:10,560 mapping from a number of sources. The maps appear unfinished - with all military camps and other strategic sites removed. These maps were initially overprinted with the National Grid. In 1970, the first 1:10,000 maps were produced using the Transverse Mercator Projection. The revision process continued until recently, with new editions appearing every 10 years or so for urban areas.

**Map Name(s) and Date(s)**

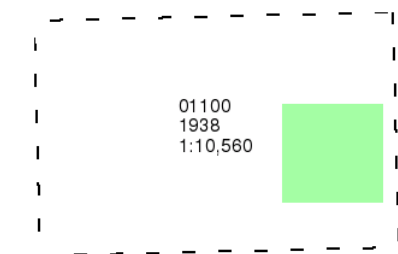

**Historical Map - Slice A**

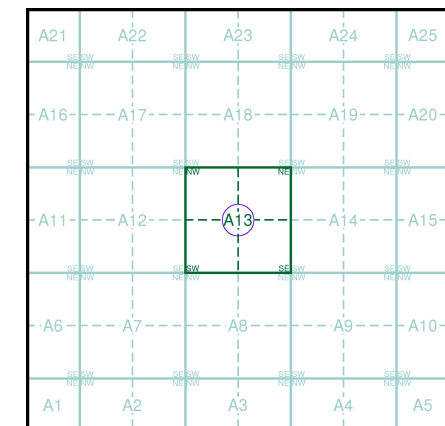

**Order Details**

Order Number: 159450375\_1\_1  
 Customer Ref: 555085, 175676  
 National Grid Reference: 555080, 175680  
 Slice: A  
 Site Area (Ha): 0.01  
 Search Buffer (m): 1000

**Site Details**

555085, 175676



Tel: 0844 844 9952  
 Fax: 0844 844 9951  
 Web: www.envirocheck.co.uk

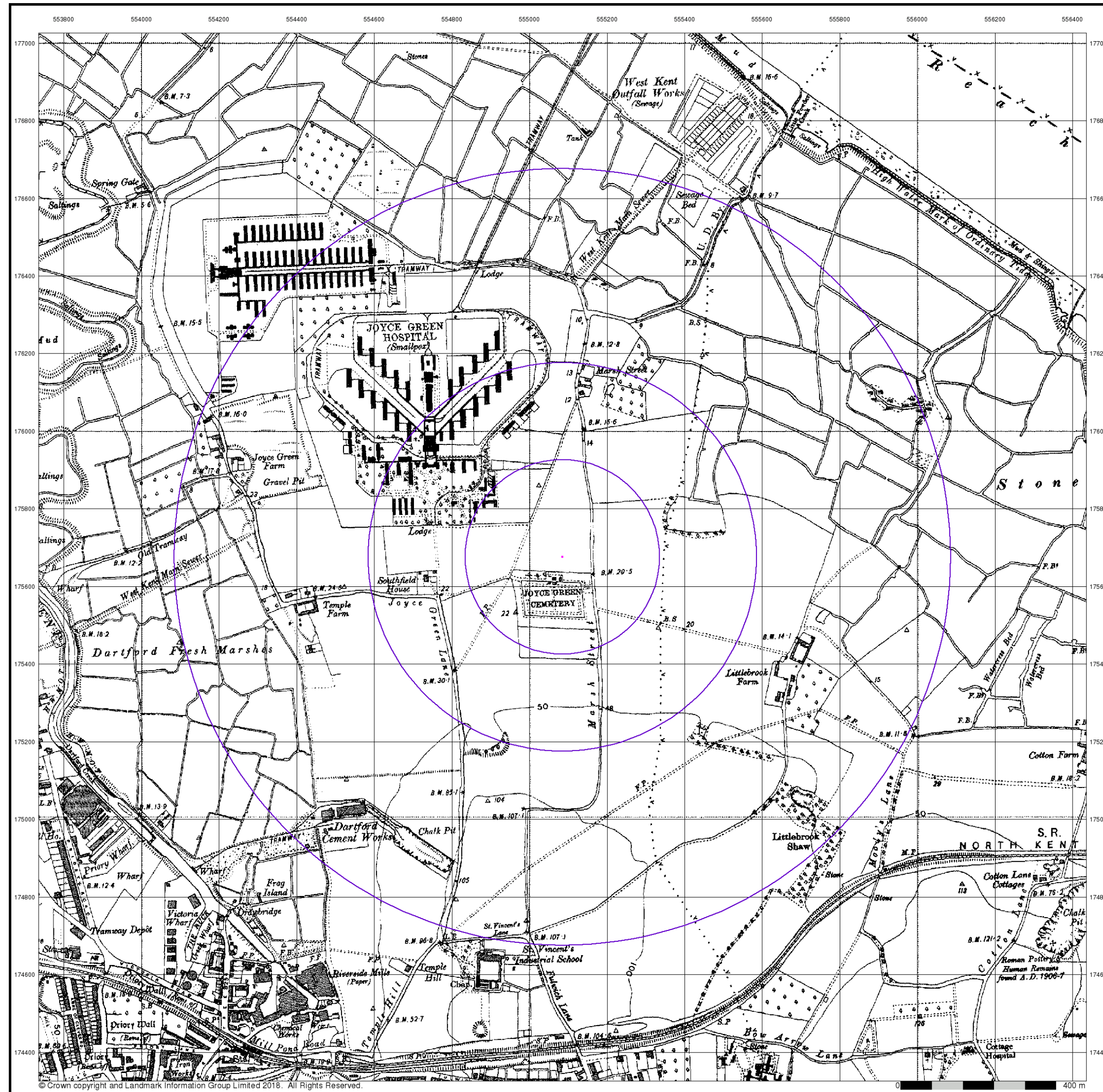

Essex

Published 1938

Source map scale - 1:10,560

The historical maps shown were reproduced from maps predominantly held at the scale adopted for England, Wales and Scotland in the 1840's. In 1854 the 1:2,500 scale was adopted for mapping urban areas; these maps were used to update the 1:10,560 maps. The published date given therefore is often some years later than the surveyed date. Before 1938, all OS maps were based on the Cassini Projection, with independent surveys of a single county or group of counties, giving rise to significant inaccuracies in outlying areas. In the late 1940's, a Provisional Edition was produced, which updated the 1:10,560 mapping from a number of sources. The maps appear unfinished - with all military camps and other strategic sites removed. These maps were initially overprinted with the National Grid. In 1970, the first 1:10,000 maps were produced using the Transverse Mercator Projection. The revision process continued until recently, with new editions appearing every 10 years or so for urban areas.

Map Name(s) and Date(s)

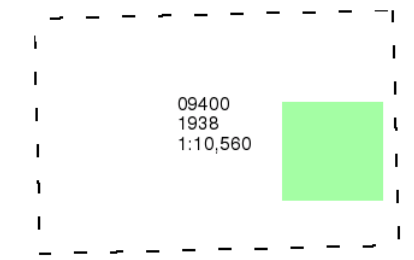

Historical Map - Slice A

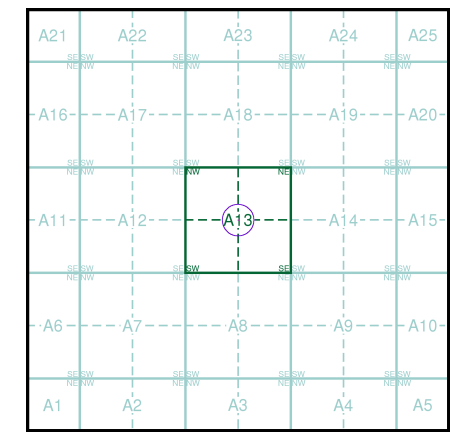

Order Details

Order Number: 159450375\_1\_1  
 Customer Ref: 555085, 175676  
 National Grid Reference: 555080, 175680  
 Slice: A  
 Site Area (Ha): 0.01  
 Search Buffer (m): 1000

Site Details

555085, 175676



Tel: 0844 844 9952  
 Fax: 0844 844 9951  
 Web: www.envirocheck.co.uk

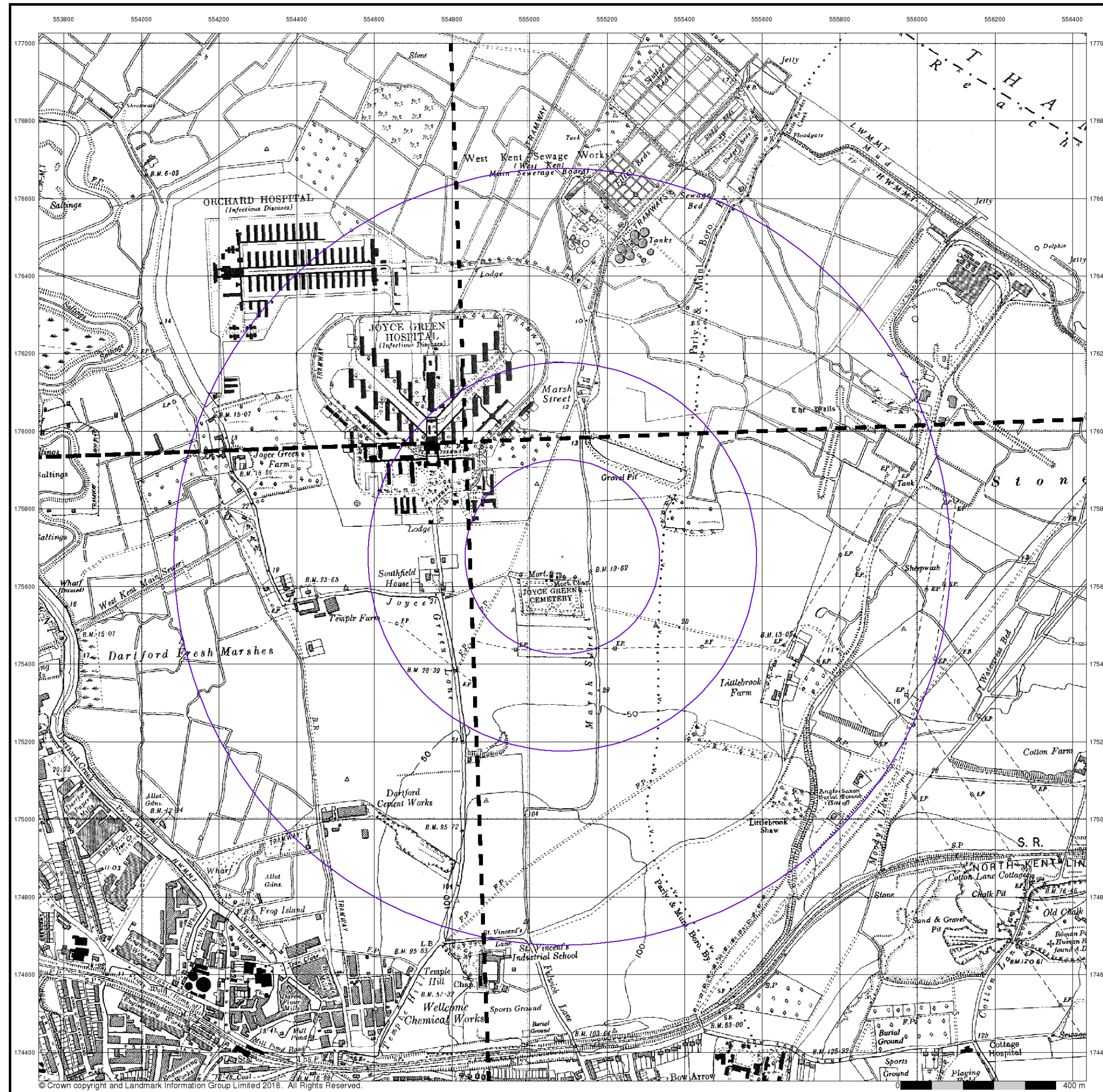

**Kent**

**Published 1939 - 1951**

**Source map scale - 1:10,560**

The historical maps shown were reproduced from maps predominantly held at the scale adopted for England, Wales and Scotland in the 1840's. In 1854 the 1:2,500 scale was adopted for mapping urban areas; these maps were used to update the 1:10,560 maps. The published date given therefore is often some years later than the surveyed date. Before 1938, all OS maps were based on the Cassini Projection, with independent surveys of a single county or group of counties, giving rise to significant inaccuracies in outlying areas. In the late 1940's, a Provisional Edition was produced, which updated the 1:10,560 mapping from a number of sources. The maps appear unfinished - with all military camps and other strategic sites removed. These maps were initially overprinted with the National Grid. In 1970, the first 1:10,000 maps were produced using the Transverse Mercator Projection. The revision process continued until recently, with new editions appearing every 10 years or so for urban areas.

**Map Name(s) and Date(s)**

003SW 1950 1:10,560	003SE 1951 1:10,560
009NW 1939 1:10,560	009NE 1950 1:10,560

**Historical Map - Slice A**

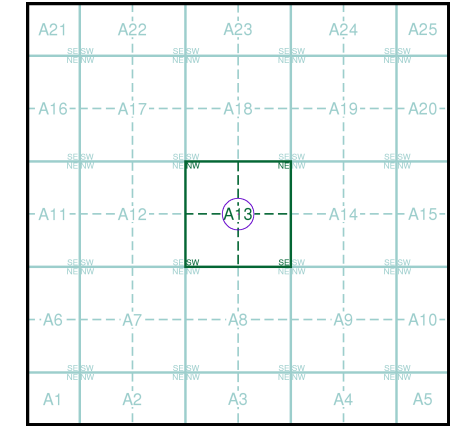

**Order Details**

Order Number: 159450375\_1\_1  
 Customer Ref: 555085, 175676  
 National Grid Reference: 555080, 175680  
 Slice: A  
 Site Area (Ha): 0.01  
 Search Buffer (m): 1000

**Site Details**

555085, 175676



Tel: 0844 844 9952  
 Fax: 0844 844 9951  
 Web: www.envirocheck.co.uk



## Historical Aerial Photography

Published 1947 - 1948

Source map scale - 1:10,560

The Historical Aerial Photos were produced by the Ordnance Survey at a scale of 1:1,250 and 1:10,560 from Air Force photography. They were produced between 1944 and 1951 as an interim measure, pending preparation of conventional mapping, due to post war resource shortages. New security measures in the 1950's meant that every photograph was re-checked for potentially unsafe information with security sites replaced by fake fields or clouds. The original editions were withdrawn and only later made available after a period of fifty years although due to the accuracy of the editing, without viewing both revisions it is not easy to spot the edits. Where available Landmark have included both revisions.

© Landmark Information Group and/or Data Suppliers 2010.

### Map Name(s) and Date(s)

TQ57NW 1948 1:10,560	TQ57NE 1947 1:10,560
TQ57SW 1947 1:10,560	TQ57SE 1947 1:10,560

### Historical Aerial Photography - Slice A

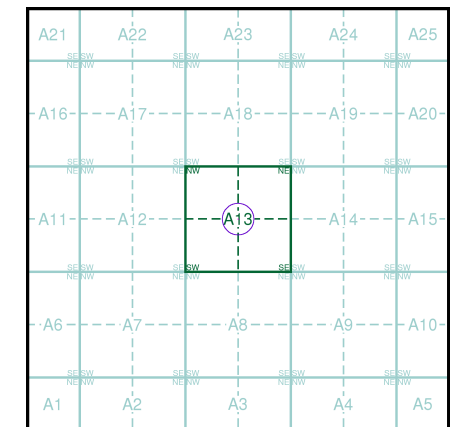

### Order Details

Order Number: 159450375\_1\_1  
 Customer Ref: 555085, 175676  
 National Grid Reference: 555080, 175680  
 Slice: A  
 Site Area (Ha): 0.01  
 Search Buffer (m): 1000

### Site Details

555085, 175676



Tel: 0844 844 9952  
 Fax: 0844 844 9951  
 Web: www.envirocheck.co.uk



## Historical Aerial Photography

Published 1947

Source map scale - 1:10,560

The Historical Aerial Photos were produced by the Ordnance Survey at a scale of 1:1,250 and 1:10,560 from Air Force photography. They were produced between 1944 and 1951 as an interim measure, pending preparation of conventional mapping, due to post war resource shortages. New security measures in the 1950's meant that every photograph was re-checked for potentially unsafe information with security sites replaced by fake fields or clouds. The original editions were withdrawn and only later made available after a period of fifty years although due to the accuracy of the editing, without viewing both revisions it is not easy to spot the edits. Where available Landmark have included both revisions.

© Landmark Information Group and/or Data Suppliers 2010.

### Map Name(s) and Date(s)

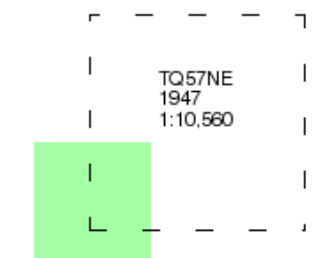

### Historical Aerial Photography - Slice A

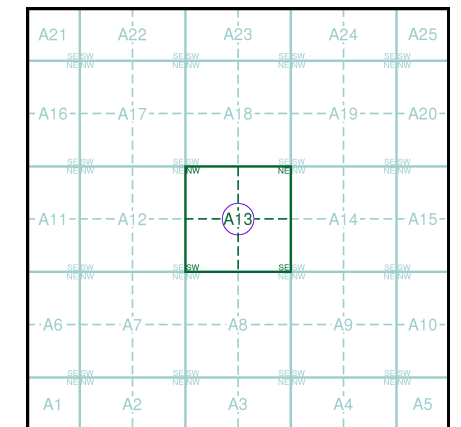

### Order Details

Order Number: 159450375\_1\_1  
 Customer Ref: 555085, 175676  
 National Grid Reference: 555080, 175680  
 Slice: A  
 Site Area (Ha): 0.01  
 Search Buffer (m): 1000

### Site Details

555085, 175676



Tel: 0844 844 9952  
 Fax: 0844 844 9951  
 Web: www.envirocheck.co.uk